

REV.	DESCRIPTION	DRAWN	CHECKED	APPROVED
A	NEW RELEASE	YCH 09/04/08'	~	

- NOTES:
- MATERIAL
    - INSULATOR:THERMOPLASTIC(UL 94V-0).
    - CONTACT: COPPER ALLOY.
  - SPECIFICATION
    - TEMPERATURE RANGE:-40~+105°C.
    - CONTACT RESISTANCE:20mΩ max.
    - INSULATION RESISTANCE:500MΩ min.
    - DIELECTRIC WITHSTANDING VOLTAGE:AC 250V PER MINUTE.
  - PART NUMBER: DS1020-02
  - PRODUCT NUMBER CODE:  
DS1020-02- X X X X

- CONTACT PLATING  
T1: TIN  
8: FULL GOLD FLASG
- HOUSING COLOR  
V: IVORY  
B: BLACK
- CONNECTOR TYPE  
M: MALE  
F: FEMALE
- No. OF CONTACTS  
02~16

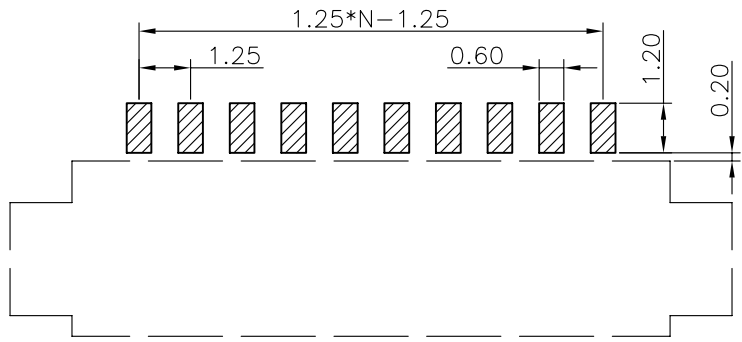
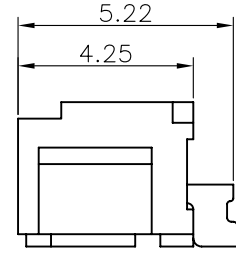
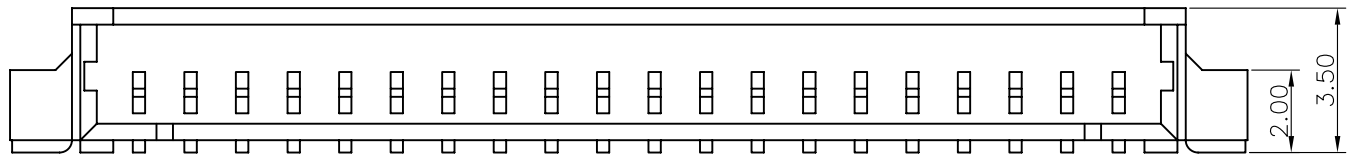
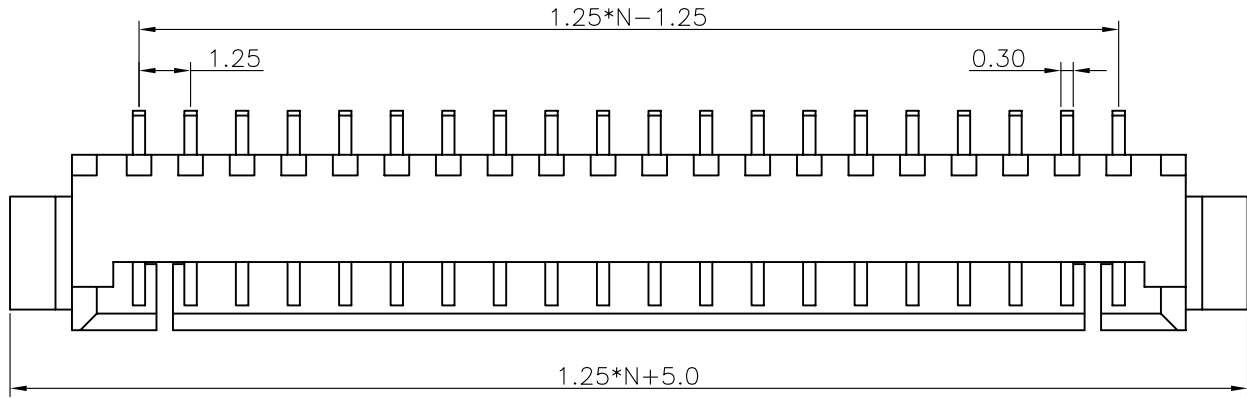

GENERAL TOLERANCE		ANGLE TOLERANCE	
X.	±0.60	X.	±5°
.X	±0.38	.X	±3°
.XX	±0.25	.XX	±2°

PROJECTION	TITLE	1.25mm WAFER CONNECTOR R/A SMT TYPE	
UNITS	mm	SHEET SIZE	A4
SHEET SIZE	A4	SERIES	DS1020-02 SERIES

DRAWING TYPE	CUSTOMER		
SCALE	1:1	SHEET	1 OF 1
DRAWING NO.	C-DS1020-02-XXXX		

**晨翔电子有限公司**  
**CONFLY CONFLY ELECTRONIC CO. LTD**

RECOMMEND PCB LAYOUT(TOLERANCE=±0.05)

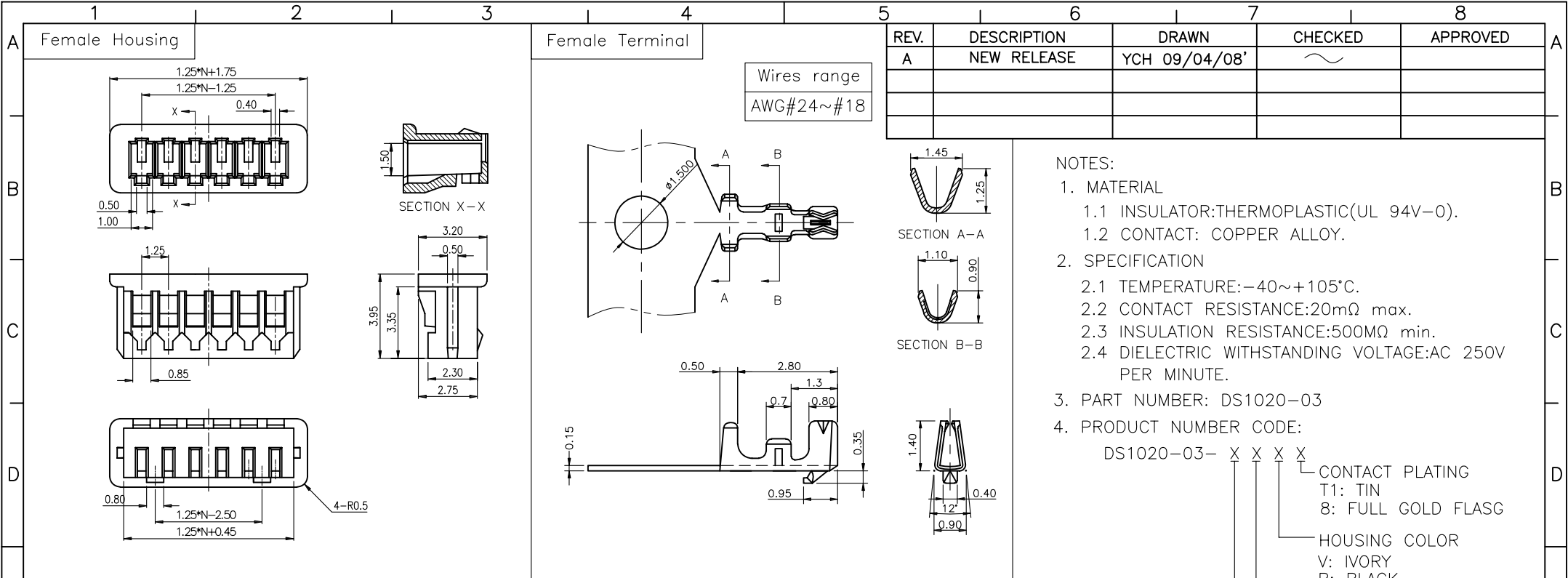

REV.	DESCRIPTION	DRAWN	CHECKED	APPROVED
A	NEW RELEASE	YCH 09/04/08'	~	

NOTES:

- MATERIAL
  - INSULATOR:THERMOPLASTIC(UL 94V-0).
  - CONTACT: COPPER ALLOY.
- SPECIFICATION
  - TEMPERATURE:-40~+105°C.
  - CONTACT RESISTANCE:20mΩ max.
  - INSULATION RESISTANCE:500MΩ min.
  - DIELECTRIC WITHSTANDING VOLTAGE:AC 250V PER MINUTE.
- PART NUMBER: DS1020-03
- PRODUCT NUMBER CODE:  
 DS1020-03- X X X X  
 CONTACT PLATING  
 T1: TIN  
 8: FULL GOLD FLASG  
 HOUSING COLOR  
 V: IVORY  
 B: BLACK  
 CONNECTOR TYPE  
 M: MALE  
 F: FEMALE  
 No. OF CONTACTS  
 02~16

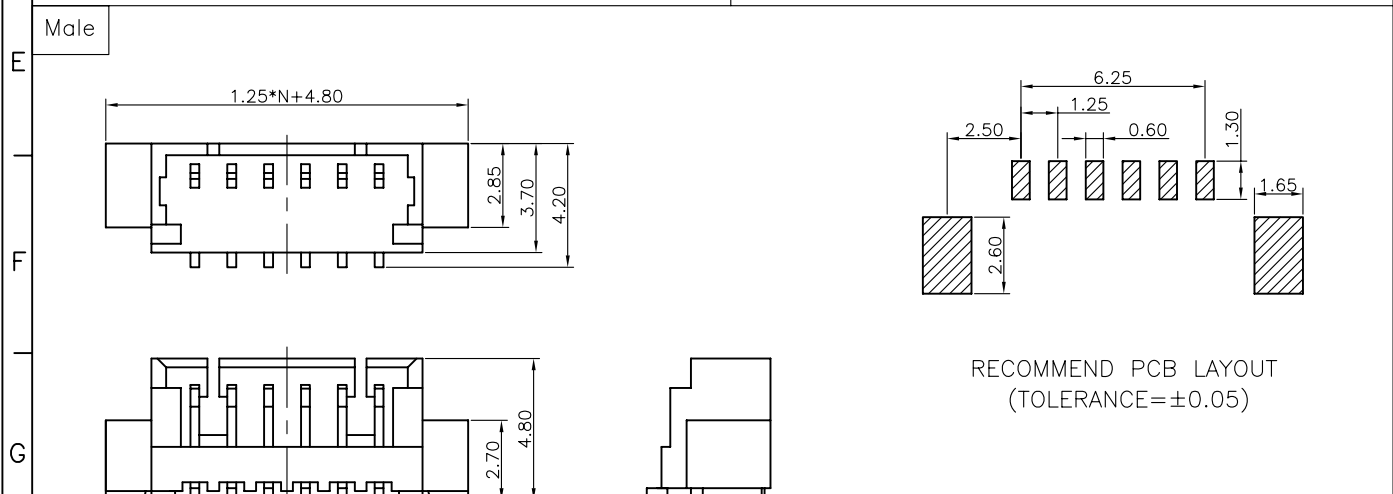

GENERAL TOLERANCE		ANGLE TOLERANCE		PROJECTION		TITLE	1.25mm WAFER CONNECTOR	
X.	±0.60	X.	±5°	UNITS	mm		V/T SMT TYPE	
.X	±0.38	.X	±3°	SHEET SIZE	A4	SERIES	DS1020-03 SERIES	
.XX	±0.25	.XX	±2°	晨翔电子有限公司 <b>CONNPLY CONNPLY ELECTRONIC CO. LTD</b>				
DRAWING TYPE		CUSTOMER						
SCALE	1:1	SHEET	1 OF 1					
DRAWING NO.		C-DS1020-03-XXXX						