

REV.	DESCRIPTION	DRAWN	CHECKED	APPROVED
A	NEW RELEASE	HP 25/06/05		

NOTES:

1. SPECIFICATIONS

- . Current Rating: 1A
- . Insulation Resistance: 500MΩ Min
- . Dielectric Withstanding: 300V AC
- . Contact Resistance: 30mΩ Max
- . Operating Temperature: -40°C to +105°C

2. MATERIALS

- . Contact Material: Copper alloy
- . Insulator: Thermoplastic(UL94 V-0).

3. PART NUMBER: DS1065-01

4. PRODUCT NUMBER CODE:

DS1065-01 - X X X X X

- MOUNTING TYPE  
V:V/T TYPE
- HOUSING COLOR  
B:BLACK
- CONTACT PLATING  
8: FULL GOLD FLASH
- CONNECTOR TYPE  
S:SOCKET
- No.OF CONTACTS  
1\*1-1\*40

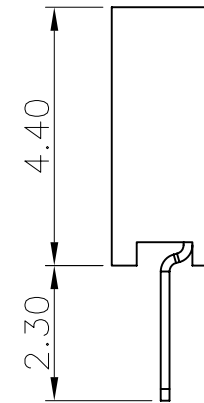
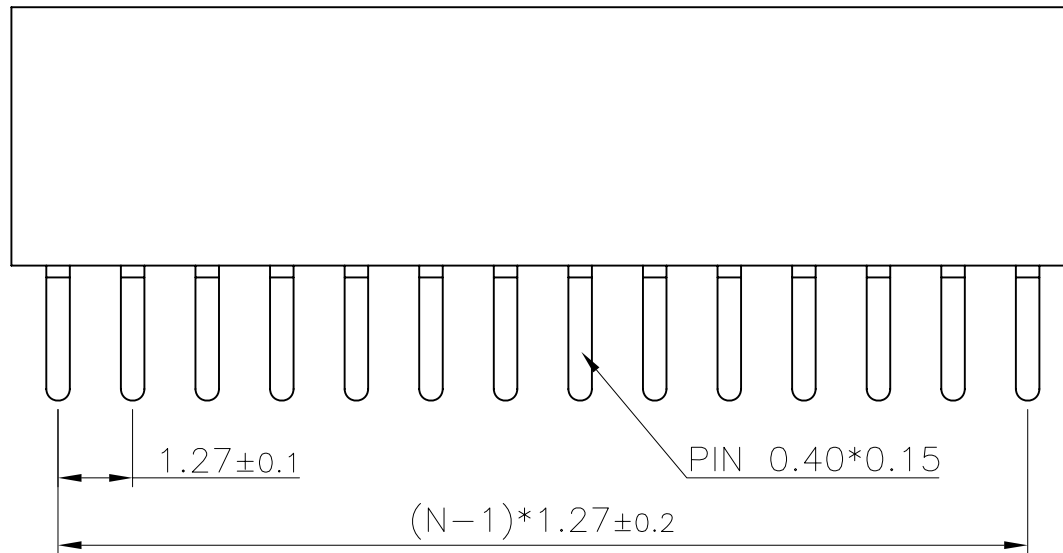
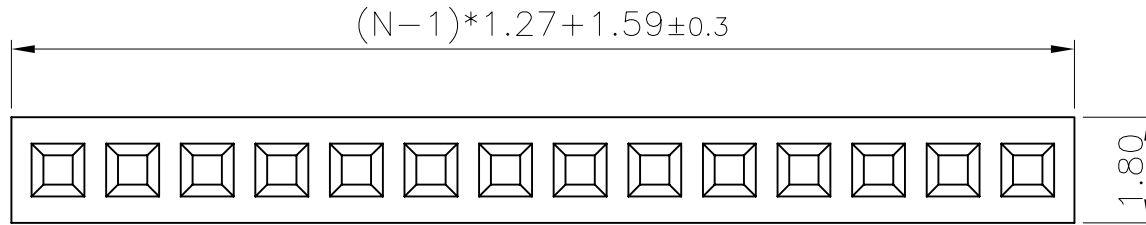

GENERAL TOLERANCE		ANGLE TOLERANCE		PROJECTION		TITLE	FEMALE HEADER PITCH 1.27mm TYPE
X.	±0.60	X.	±5°	UNITS	mm	SINGLE ROW V/T TYPE	
.X	±0.38	.X	±3°	SHEET SIZE	A4	SERIES	DS1065-01
.XX	±0.25	.XX	±2°	<b>晨翔电子有限公司</b> <b>CONNFLY CONNFLY ELECTRONIC CO. LTD</b>			
DRAWING TYPE		CUSTOMER					
SCALE	1:1	SHEET	1 OF 1				
DRAWING NO.		C-DS1065-01-XXXXX					

REV.	DESCRIPTION	DRAWN	CHECKED	APPROVED
A	NEW RELEASE	YCH 12/08/11	~	

NOTES:

1. SPECIFICATIONS

- . Current Rating: 1A
- . Insulation Resistance: 500MΩ Min
- . Dielectric Withstanding: 300V AC
- . Contact Resistance: 30mΩ Max
- . Operating Temperature: -40°C to +105°C

2. MATERIALS

- . Contact Material: Copper alloy
- . Insulator: Thermoplastic(UL94 V-0)

3. PART NUMBER: DS1065-07

4. PRODUCT NUMBER CODE:

DS1065-07 -

- |   |   |   |   |          |                    |
|---|---|---|---|----------|--------------------|
| X | X | X | X | X        |                    |
|   |   |   |   |          | MOUNTING TYPE      |
|   |   |   |   | V        | V:VERTICAL TYPE    |
|   |   |   |   |          | HOUSING COLOR      |
|   |   |   |   | B        | B:BLACK            |
|   |   |   |   |          | CONTACT PLATING    |
|   |   |   |   | 8        | 8: FULL GOLD FLASH |
|   |   |   |   |          | CONNECTOR TYPE     |
|   |   |   |   | S        | S:SOCKET           |
|   |   |   |   |          | No.OF CONTACTS     |
|   |   |   |   | 1*1-1*40 |                    |

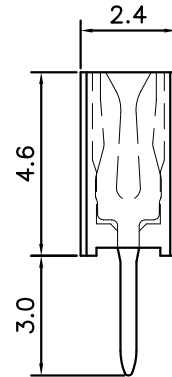
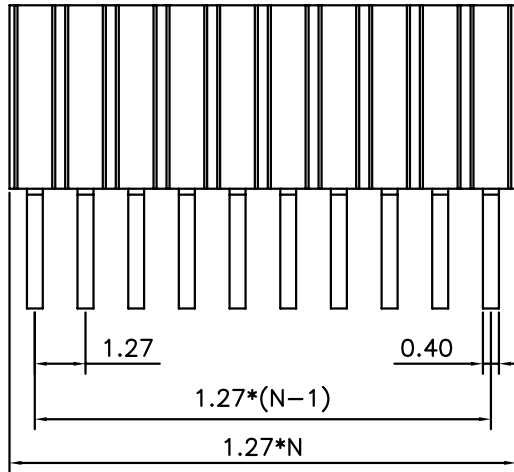
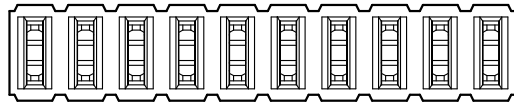

N=No.of Contacts

GENERAL TOLERANCE		ANGLE TOLERANCE		PROJECTION		TITLE	FEMALE HEADER PITCH 1.27mm TYPE
X.	±0.60	X.	±5°	UNITS	mm	SINGLE ROW STRAIGHT	
.X	±0.38	.X	±3°	SHEET SIZE	A4	SERIES	DS1065-07
.XX	±0.25	.XX	±2°	<b>晨翔电子有限公司</b> <b>CONNFLY CONNFLY ELECTRONIC CO. LTD</b>			
DRAWING TYPE		CUSTOMER					
SCALE	1:1	SHEET	1 OF 1				
DRAWING NO.		C-DS1065-07-XXXXX					

REV.	DESCRIPTION	DRAWN	CHECKED	APPROVED
A	NEW RELEASE	HP 25/06/05		

N=No. of contacts/2

$$(N-1)*1.27+1.59\pm0.3$$

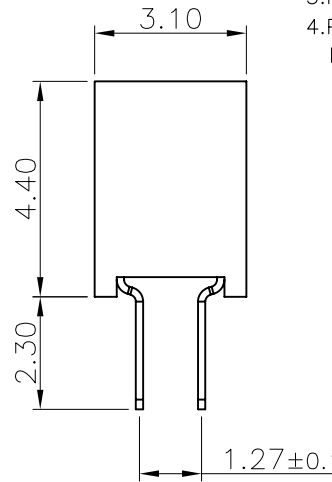
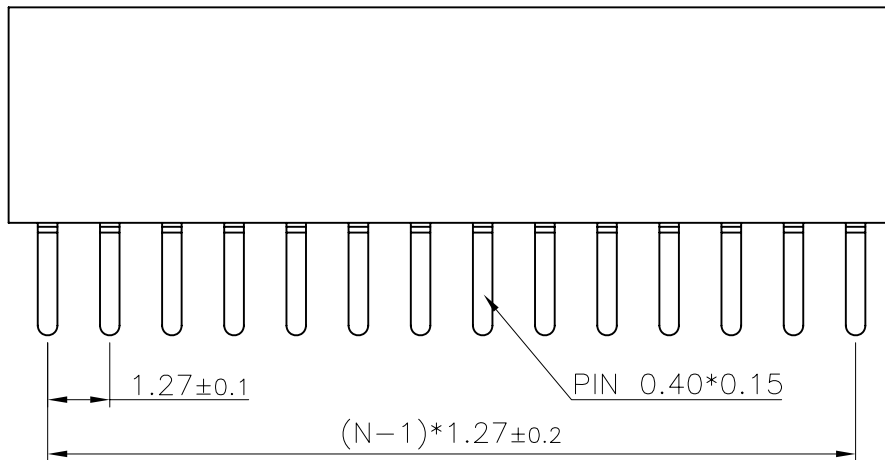
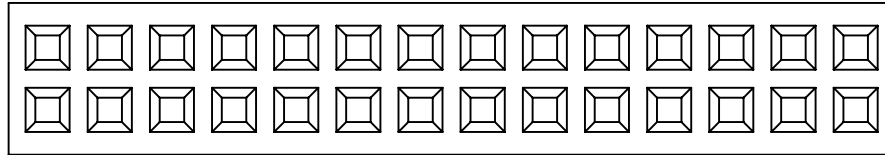

NOTES:

1. SPECIFICATIONS

- . Current Rating: 1A
- . Insulation Resistance: 500MΩ Min
- . Dielectric Withstanding: 300V AC
- . Contact Resistance: 30mΩ Max
- . Operating Temperature: -40°C to +105°C

2. MATERIALS

- . Contact Material: Copper alloy
- . Insulator: Thermoplastic(UL94 V-0)

3. PART NUMBER: DS1065-03

4. PRODUCT NUMBER CODE:

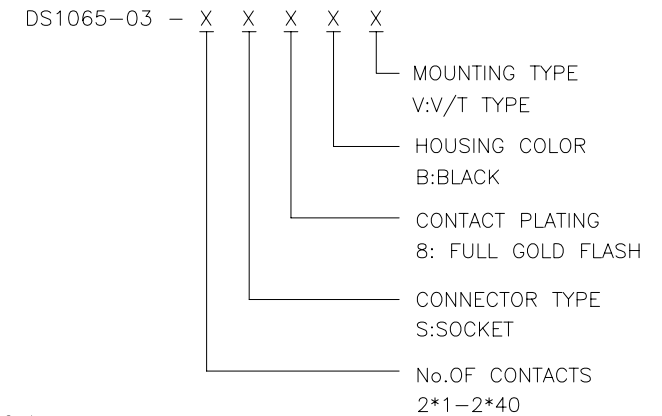

GENERAL TOLERANCE		ANGLE TOLERANCE		PROJECTION		TITLE	FEMALE HEADER PITCH 1.27mm TYPE
X.	±0.60	X.	±5°	UNITS	mm	WITHOUT POLARIZATION V/T TYPE	
.X	±0.38	.X	±3°	SHEET SIZE	A4	SERIES	DS1065-03
.XX	±0.25	.XX	±2°	<b>晨翔电子有限公司</b> <b>CONNFLY CONNFLY ELECTRONIC CO. LTD</b>			
DRAWING TYPE		CUSTOMER					
SCALE	1:1	SHEET	1 OF 1				
DRAWING NO.		C-DS1065-03-XXXXX					

REV.	DESCRIPTION	DRAWN	CHECKED	APPROVED
A	NEW RELEASE	YCH 06/03/11'	~	

N=No. of contacts/2

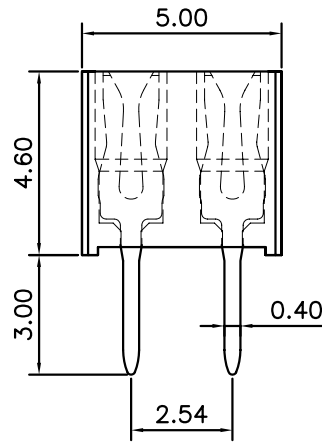
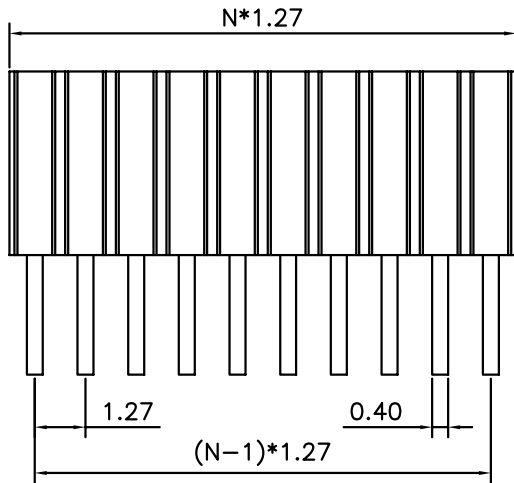
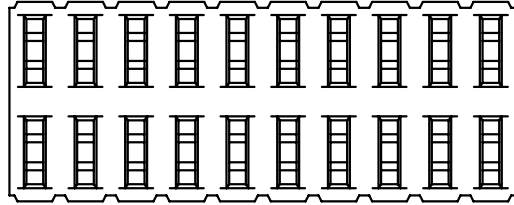

NOTES:

1. SPECIFICATIONS

- . Current Rating: 1A
- . Insulation Resistance: 500MΩ Min
- . Dielectric Withstanding: 300V AC
- . Contact Resistance: 30mΩ Max
- . Operating Temperature: -40°C to +105°C

2. MATERIALS

- . Contact Material: Copper alloy
- . Insulator: thermoplastic(UL94V-0)

3. PART NUMBER: DS1065-08

4. PRODUCT NUMBER CODE:

DS1065-08 - X X X X X

- MOUNTING TYPE  
V: VERTICAL TYPE
- HOUSING COLOR  
B: BLACK
- CONTACT PLATING  
8: FULL GOLD FLASH
- CONNECTOR TYPE  
S: SOCKET
- No. OF CONTACTS  
2\*1-2\*40

GENERAL TOLERANCE		ANGLE TOLERANCE		PROJECTION		TITLE	FEMALE HEADER PITCH 1.27mm TYPE
X.	±0.60	X.	±5°	UNITS	mm	DUAL ROW STRAIGHT	
.X	±0.38	.X	±3°	SHEET SIZE	A4	SERIES	DS1065-08
.XX	±0.25	.XX	±2°	<b>晨翔电子有限公司</b> <b>CONNFLY CONNFLY ELECTRONIC CO. LTD</b>			
DRAWING TYPE		CUSTOMER					
SCALE	1:1	SHEET	1 OF 1				
DRAWING NO.		C-DS1065-08-XXXXX					

REV.	DESCRIPTION	DRAWN	CHECKED	APPROVED
A	NEW RELEASE	HP 26/06/05		

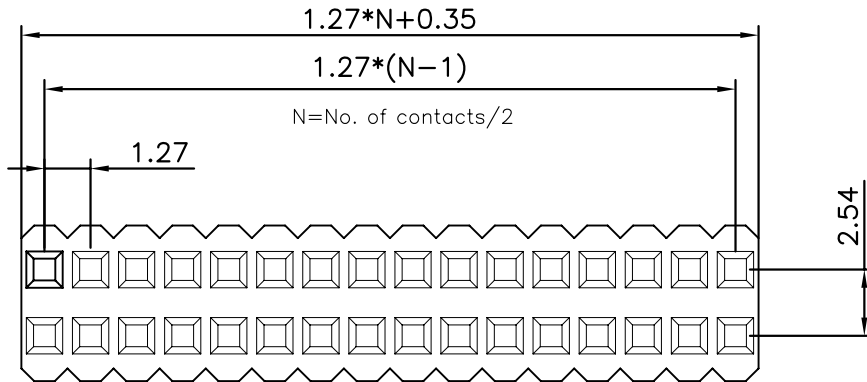

NOTES:

1. SPECIFICATIONS

- . Current Rating: 1A
- . Insulation Resistance: 500MΩ Min
- . Dielectric Withstanding: 300V AC
- . Contact Resistance: 30mΩ Max
- . Operating Temperature: -40°C to +105°C

2. MATERIALS

- . Contact Material: Copper alloy
- . Insulator: Thermoplastic(UL94 V-0)

3. PART NUMBER: DS1065-09

4. PRODUCT NUMBER CODE:

DS1065-09 - X X X X X

- MOUNTING TYPE  
V: VERTICAL TYPE
- HOUSING COLOR  
B: BLACK
- CONTACT PLATING  
8: FULL GOLD FLASH
- CONNECTOR TYPE  
S: SOCKET
- No. OF CONTACTS  
2\*1-2\*40

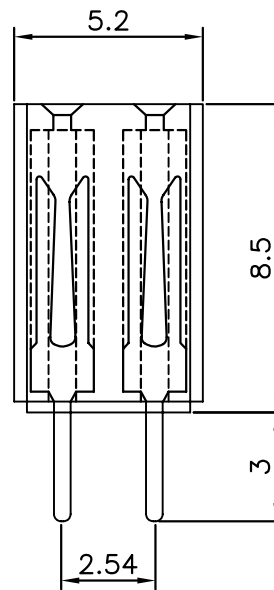
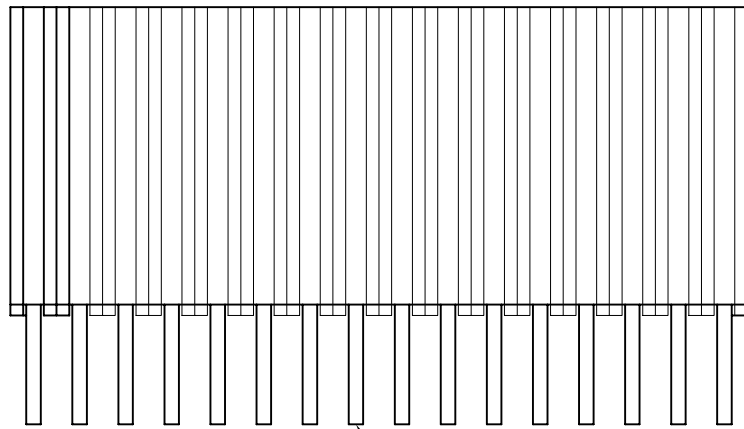

GENERAL TOLERANCE		ANGLE TOLERANCE		PROJECTION		TITLE	FEMALE HEADER PITCH 1.27mm TYPE DUAL ROW 8.5mm HEIGHT
X.	±0.60	X.	±5°	UNITS	mm		
.X	±0.38	.X	±3°	SHEET SIZE	A4	SERIES	DS1065-09
.XX	±0.25	.XX	±2°	<b>晨翔电子有限公司</b> <b>CONNFLY ELECTRONIC CO. LTD</b>			
DRAWING TYPE		CUSTOMER					
SCALE	1:1	SHEET	1 OF 1				
DRAWING NO.		C-DS1065-09-XXXXX					

REV.	DESCRIPTION	DRAWN	CHECKED	APPROVED
A	NEW RELEASE	HP 25/06/05		

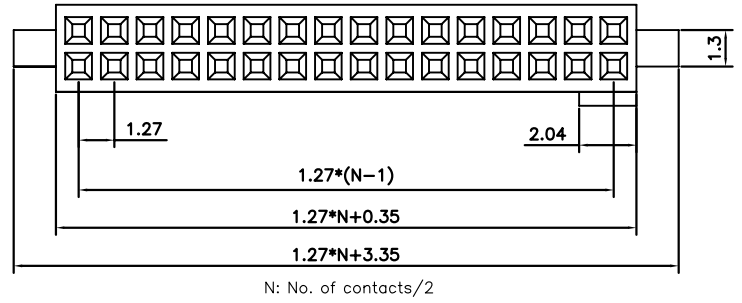

- NOTES:
- SPECIFICATIONS
    - Current Rating: 1A
    - Insulation Resistance: 500MΩ Min
    - Dielectric Withstanding: 300V AC
    - Contact Resistance: 30mΩ Max
    - Operating Temperature: -40°C to +105°C

- MATERIALS
  - Contact Material: Copper alloy
  - Insulator: Thermoplastic(UL94 V-0)

3.PART NUMBER: DS1065-04

4.PRODUCT NUMBER CODE:

DS1065-04 - X X X X X

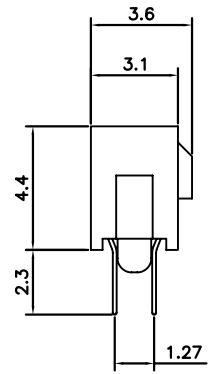
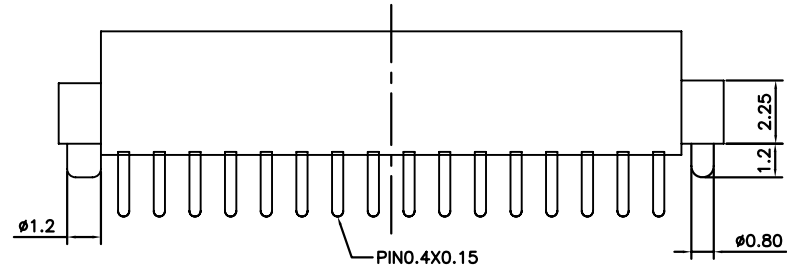

- MOUNTING TYPE  
V:V/T TYPE
- HOUSING COLOR  
B:BLACK
- CONTACT PLATING  
8: FULL GOLD FLASH
- CONNECTOR TYPE  
S:SOCKET
- No.OF CONTACTS  
2\*1-2\*40

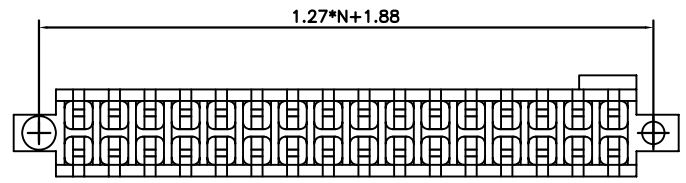

GENERAL TOLERANCE	ANGLE TOLERANCE
X. ±0.60	X. ±5°
.X ±0.38	.X ±3°
.XX ±0.25	.XX ±2°

PROJECTION	UNITS	SHEET SIZE	TITLE	WITH POLARIZATION AND LOCAL PEG V/T TYPE
	mm	A4	SERIES	DS1065-04

DRAWING TYPE	SCALE	DRAWING NO.	CUSTOMER	SHEET
	1:1	C-DS1065-04-XXXXX		1 OF 1

晨翔电子有限公司  
**CONNFLY CONNFLY ELECTRONIC CO. LTD**

REV.	DESCRIPTION	DRAWN	CHECKED	APPROVED
A	NEW RELEASE	HP 25/06/05		

N=No. of contacts/2

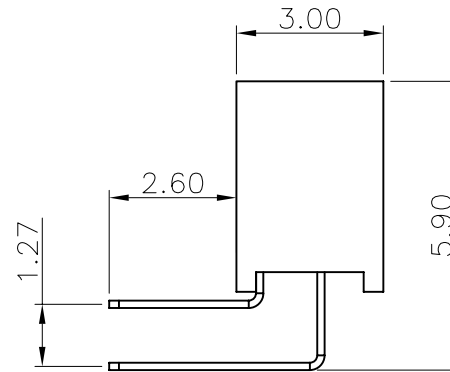
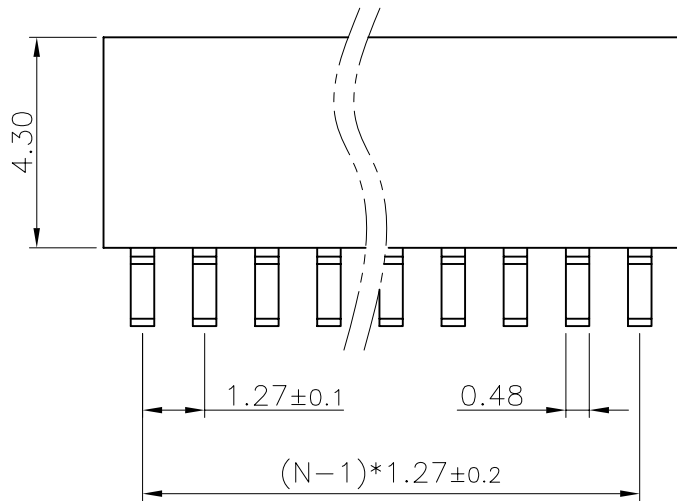
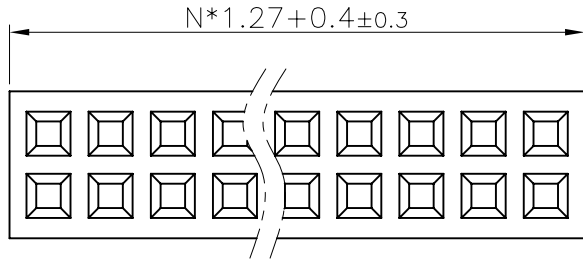

NOTES:

1. SPECIFICATIONS

- . Current Rating: 1A
- . Insulation Resistance: 500MΩ Min
- . Dielectric Withstanding: 300V AC
- . Contact Resistance: 30mΩ Max
- . Operating Temperature: -40°C to+105°C

2.MATERIALS

- . Contact Material: Copper alloy
- . Insulator: Thermoplastic(UL94 V-0)

3.PART NUMBER: DS1065-14

4.PRODUCT NUMBER CODE:

DS1065-14 - X X X X X

- MOUNTING TYPE  
R:R/A TYPE
- HOUSING COLOR  
B:BLACK
- CONTACT PLATING  
8: FULL GOLD FLASH
- CONNECTOR TYPE  
S:SOCKET
- No.OF CONTACTS  
2\*1-2\*40

GENERAL TOLERANCE		ANGLE TOLERANCE		PROJECTION		TITLE	FEMALE HEADER PITCH 1.27mm
X.	±0.60	X.	±5°	UNITS	mm		R/A TYPE
.X	±0.38	.X	±3°	SHEET SIZE	A4	SERIES	DS1065-14
.XX	±0.25	.XX	±2°	<b>晨翔电子有限公司</b> <b>CONNFLY CONNFLY ELECTRONIC CO. LTD</b>			
DRAWING TYPE		CUSTOMER					
SCALE	1:1	SHEET	1 OF 1				
DRAWING NO.		C-DS1065-14-XXXXX					

REV.	DESCRIPTION	DRAWN	CHECKED	APPROVED
A	NEW RELEASE	HP 25/06/05		

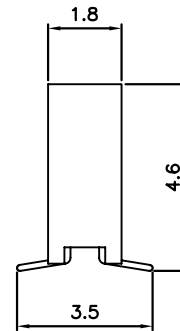
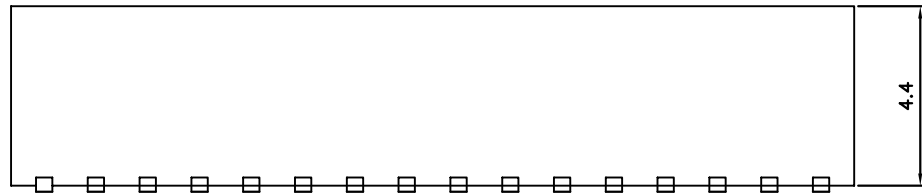
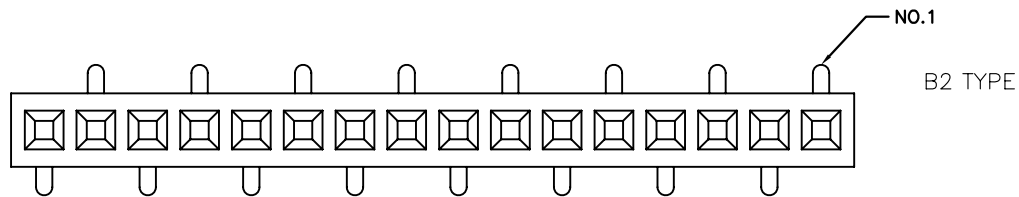
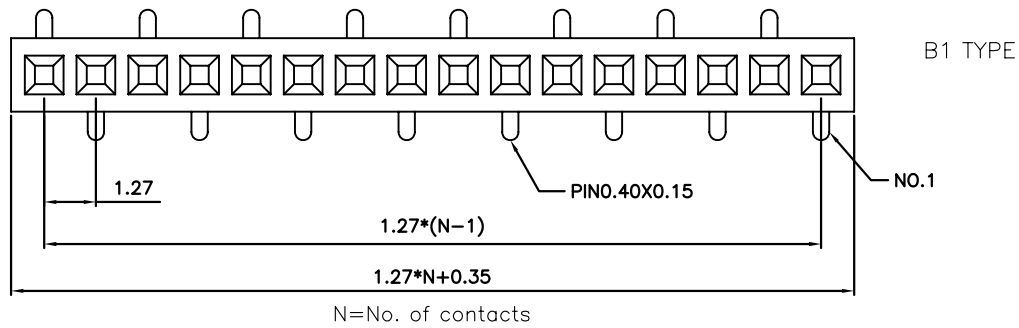

NOTES:

1. SPECIFICATIONS

- . Current Rating: 1A
- . Insulation Resistance: 500MΩ Min
- . Dielectric Withstanding: 300V AC
- . Contact Resistance: 30mΩ Max
- . Operating Temperature: -40°C to +105°C

2. MATERIALS

- . Contact Material: Copper alloy
- . Insulator: Thermoplastic(UL94 V-0)

3. PART NUMBER: DS1065-02

4. PRODUCT NUMBER CODE:

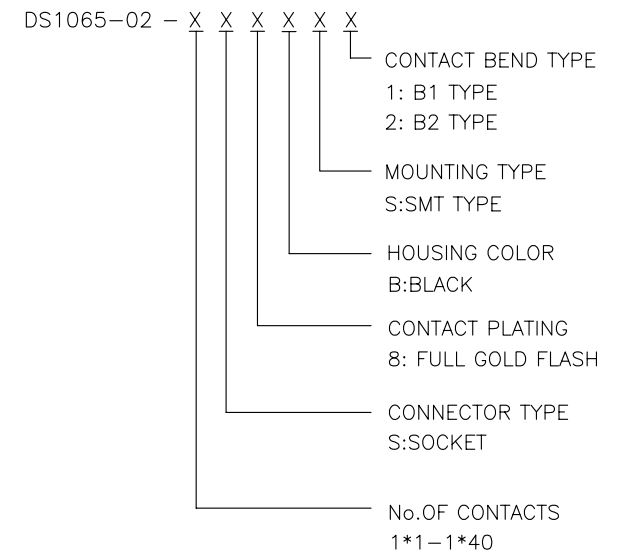

GENERAL TOLERANCE		ANGLE TOLERANCE		PROJECTION		TITLE	FEMALE HEADER PITCH 1.27mm TYPE
X.	±0.60	X.	±5°	UNITS	mm	SINGLE ROW S.M.T	
.X	±0.38	.X	±3°	SHEET SIZE	A4	SERIES	DS1065-02
.XX	±0.25	.XX	±2°	<b>晨翔电子有限公司</b> <b>CONNFLY CONNFLY ELECTRONIC CO. LTD</b>			
DRAWING TYPE		CUSTOMER					
SCALE	1:1	SHEET	1 OF 1				
DRAWING NO.		C-DS1065-02-XXXXXX					



REV.	DESCRIPTION	DRAWN	CHECKED	APPROVED
A	NEW RELEASE	YCH 11/05/08	~	

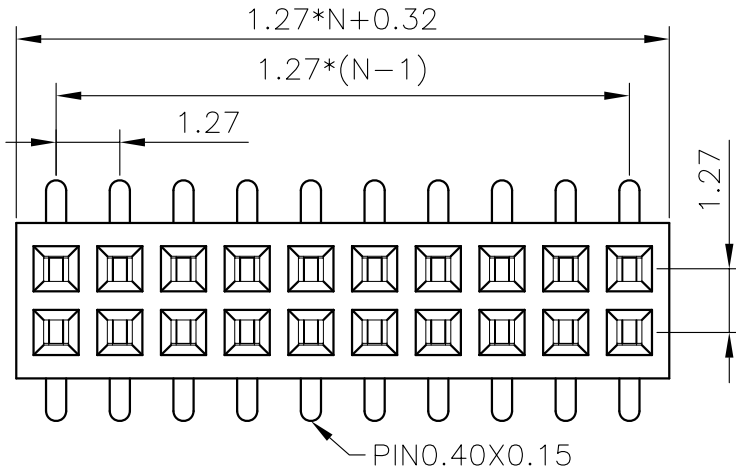

NOTES:

1. SPECIFICATIONS

- . Current Rating: 1A
- . Insulation Resistance: 500MΩ Min
- . Dielectric Withstanding: 300V AC
- . Contact Resistance: 30mΩ Max
- . Operating Temperature: -40°C to +105°C

2.PART NUMBER: DS1065-05

3.PRODUCT NUMBER CODE:

DS1065-05 - X X X X X

- MOUNTING TYPE  
S:SMT TYPE
- HOUSING COLOR  
B:BLACK
- CONTACT PLATING  
8: FULL GOLD FLASH
- CONNECTOR TYPE  
S:SOCKET
- No.OF CONTACTS  
2\*1-2\*40

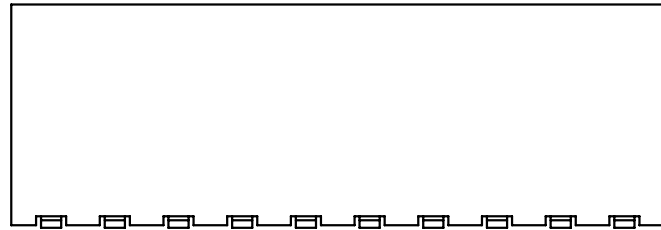
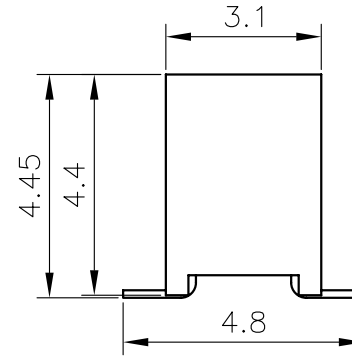

N=No. of contacts/2

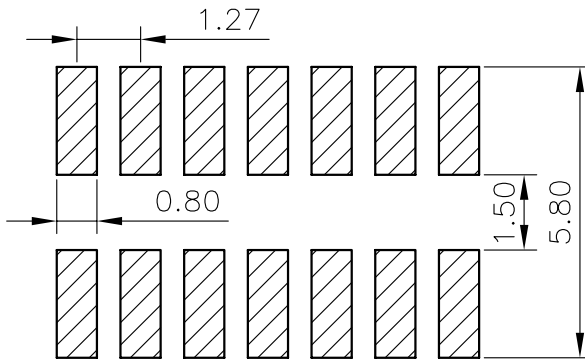

RECOMMEND PCB LAYOUT(TOLERANCE ±0.05)

GENERAL TOLERANCE		ANGLE TOLERANCE		PROJECTION	TITLE	FEMALE HEADER PITCH 1.27mm S.M.T TYPE	
X.	±0.60	X.	±5°	mm			
.X	±0.38	.X	±3°	A4	SERIES	DS1065-05	
.XX	±0.25	.XX	±2°				
DRAWING TYPE		CUSTOMER		 <b>晨翔电子有限公司</b> <b>CONNLY ELECTRONIC CO. LTD</b>			
SCALE		1:1					
DRAWING NO.		C-DS1065-05-XXXXX					

REV.	DESCRIPTION	DRAWN	CHECKED	APPROVED
A	NEW RELEASE	LJC 05/09/08'		

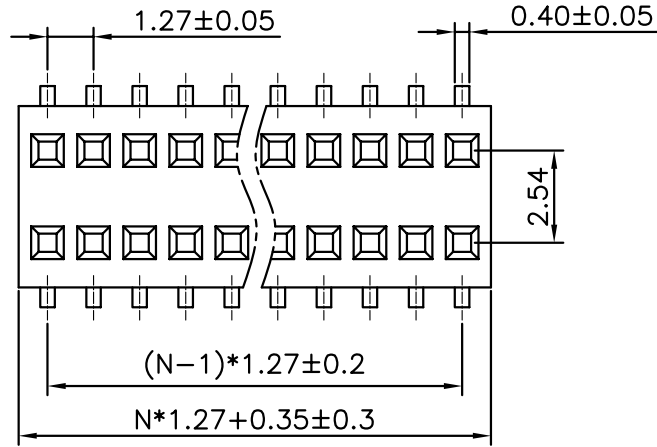

N=NO. OF CONTACTS/2

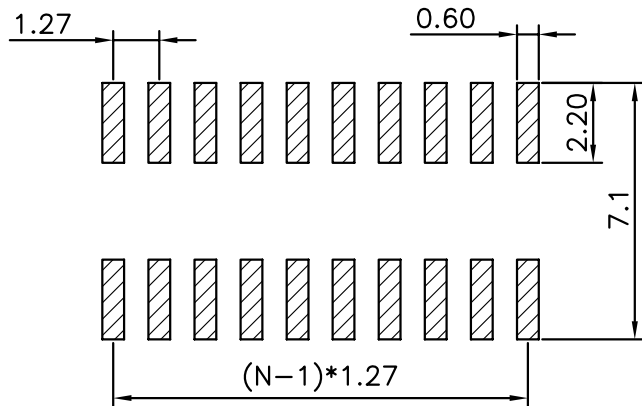
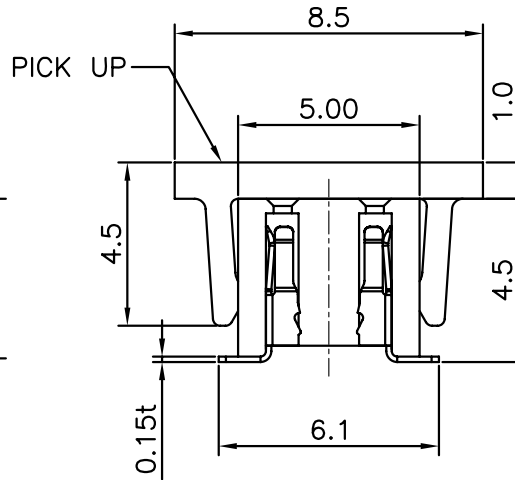
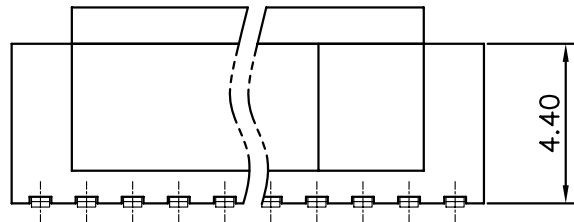

Recommend PCB Layout  
Tolerance=±0.05

NOTES:

1. SPECIFICATIONS

- . Current Rating: 1A.
- . Insulation Resistance: 500MΩ Min.
- . Dielectric Withstanding: 300V AC.
- . Contact Resistance: 20mΩ Max.
- . Operating Temperature: -40°C to+105°C.

2.MATERIALS

- . Contact Material: Copper alloy
- . Insulator: High Temperature Materials(UL94V-0).

3.PART NUMBER: DS1065-10

4.PRODUCT NUMBER CODE:

DS1065-10 - X X X X X X

- PACKING TYPE  
A: TUBE  
R: TAPE ON REEL  
T: TRAY
- PICK UP SUPPORT  
S: W/ PICK UP  
X: W/O PICK UP
- HOUSING COLOR  
B:BLACK
- CONTACT PLATING  
8: FULL GOLD FLASH
- MOUNTING TYPE  
S:SMT TYPE
- No.OF CONTACTS  
2\*2-2\*40

GENERAL TOLERANCE		ANGLE TOLERANCE	
X.	±0.60	X.	±5°
.X	±0.38	.X	±3°
.XX	±0.25	.XX	±2°

PROJECTION	TITLE
	1.27*2.54mm Female Header SMT TYPE
UNITS	mm
SHEET SIZE	A4
SERIES	DS1065-10

DRAWING TYPE	CUSTOMER		
SCALE	1:1	SHEET	1 OF 1
DRAWING NO.	C-DS1065-10-XXXXX		

晨翔电子有限公司  
CONNFLY CONNFLY ELECTRONIC CO. LTD

REV.	DESCRIPTION	DRAWN	CHECKED	APPROVED
A	NEW RELEASE	HP 26/06/05		

NOTES:

1. SPECIFICATIONS

- . Current Rating: 1A
- . Insulation Resistance: 500MΩ Min
- . Dielectric Withstanding: 300V AC
- . Contact Resistance: 30mΩ Max
- . Operating Temperature: -40°C to +105°C

2. MATERIALS

- . Contact Material: Copper alloy
- . Insulator: Thermoplastic(UL94 V-0)

3. PART NUMBER: DS1065-06

4. PRODUCT NUMBER CODE:

DS1065-06 - X X X X X

- MOUNTING TYPE  
S: SMT TYPE
- HOUSING COLOR  
B: BLACK
- CONTACT PLATING  
8: FULL GOLD FLASH
- CONNECTOR TYPE  
S: SOCKET
- No. OF CONTACTS  
2\*1-2\*40

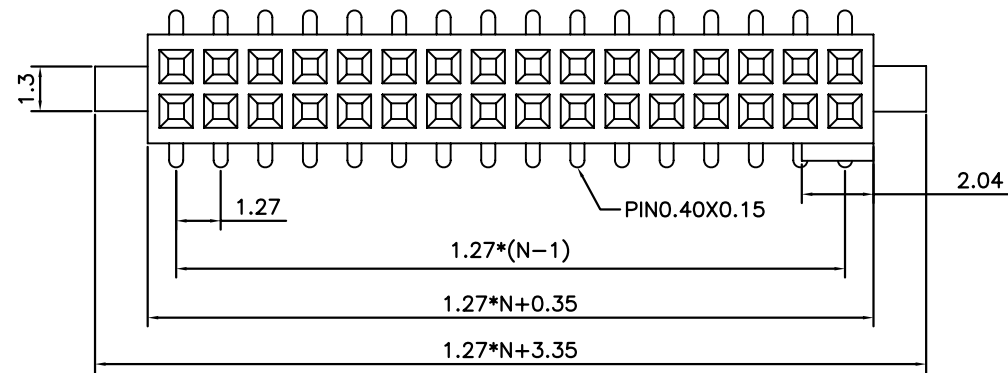

N: No. of contacts/2

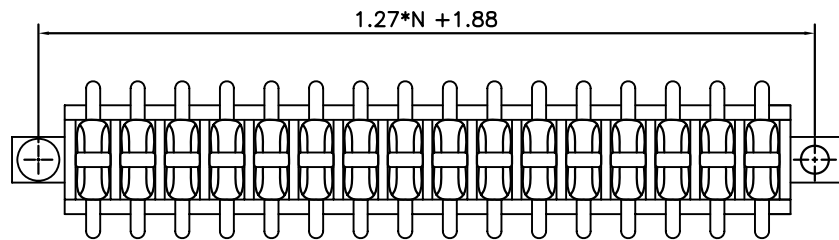
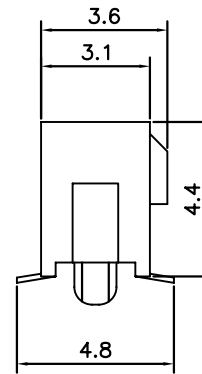
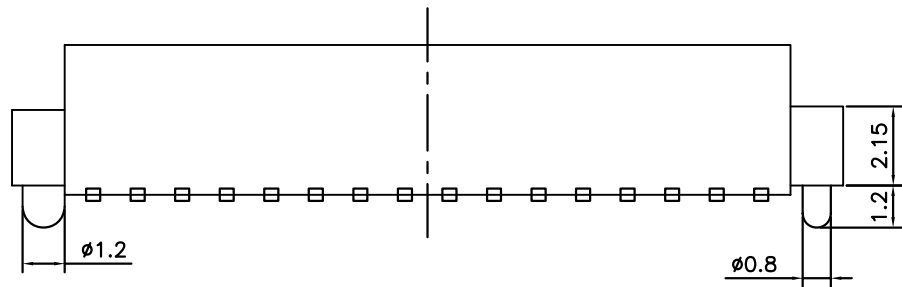

GENERAL TOLERANCE		ANGLE TOLERANCE		PROJECTION		TITLE	FEMALE HEADER PITCH 1.27mm TYPE
X.	±0.60	X.	±5°	UNITS	mm	WITH POLARIZATION AND LOCAL PEG S.M.T	
.X	±0.38	.X	±3°	SHEET SIZE	A4	SERIES	DS1065-06
.XX	±0.25	.XX	±2°	<b>晨翔电子有限公司</b> <b>CONNFLY CONNFLY ELECTRONIC CO. LTD</b>			
DRAWING TYPE		CUSTOMER					
SCALE	1:1	SHEET	1 OF 1				
DRAWING NO.		C-DS1065-06-XXXXX					