

REV.	DESCRIPTION	DRAWN	CHECKED	APPROVED
A	NEW RELEASE	YCH 03/24/09	~	

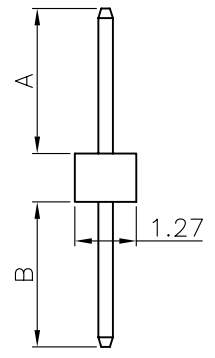

NOTES:

- MATERIAL
 - INSULATOR:THERMOPLASTIC(UL 94V-0).
 - CONTACT MATERIAL:COPPER ALLOY.
- SPECIFICATION
 - CURRENT RATING:1.0 Amp.
 - INSULATION RESISTANCE:500MΩ Min.
 - DIELECTRIC WITHSTANDING:300VAC.
 - CONTACT RESISTANCE:20mΩ Max.
 - OPERATING TEMPERATURE:-40°C TO+105°C.
- PART NUMBER: DS1031-17
- PRODUCT NUMBER CODE:
 DS1031-17 - X X X X X X
 DIM.A B TYPE
 1: TYPE 1
 MOUNTING TYPE
 V: VERTICAL TYPE
 HOUSING COLOR
 B:BLACK
 CONTACT PLATING
 8: FULL GOLD FLASH
 CONNECTOR TYPE
 P:PLUG
 No.OF CONTACTS
 1*1-1*40

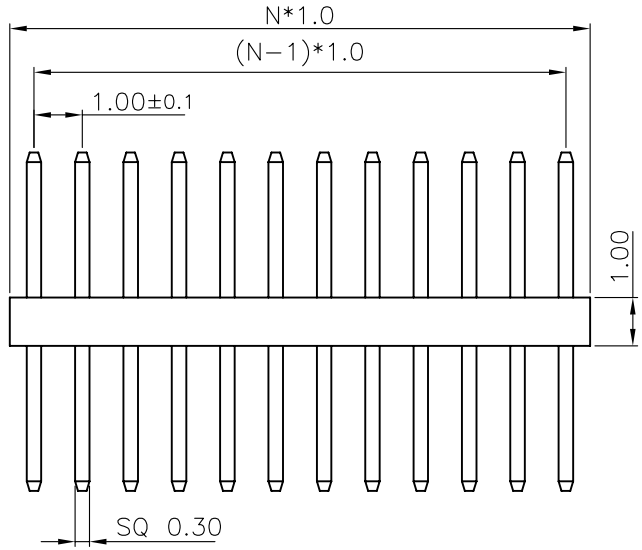
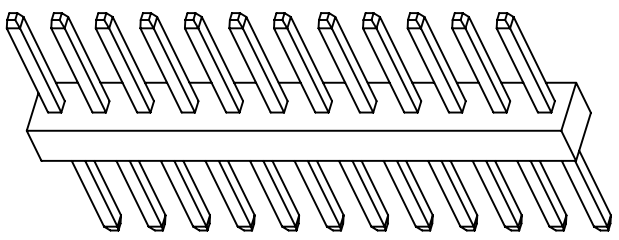

TYPE	DIM A	DIM B
1	3.00	3.00
2		
3		
4		
5		
6		
7		
8		
9		
10		

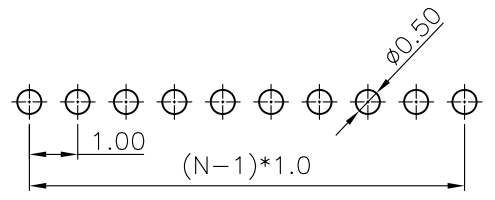

RECOMMEND PCB LAYOUT(TOLERANCE=±0.05)

GENERAL TOLERANCE		ANGLE TOLERANCE		PROJECTION		TITLE	SINGLE ROW PIN HEADER	
X.	±0.60	X.	±5°	UNITS	mm	PITCH 1.00mm V/T TYPE		
.X	±0.38	.X	±3°	SHEET SIZE	A4	SERIES	DS1031-17 SERIES	
.XX	±0.25	.XX	±2°	晨翔电子有限公司 CONNFLY CONNFLY ELECTRONIC CO. LTD				
DRAWING TYPE		CUSTOMER						
SCALE	1:1	SHEET	1 OF 1					
DRAWING NO.		C-DS1031-17-XXXXXX						

REV.	DESCRIPTION	DRAWN	CHECKED	APPROVED
A	NEW RELEASE	YCH 03/24/09	~	

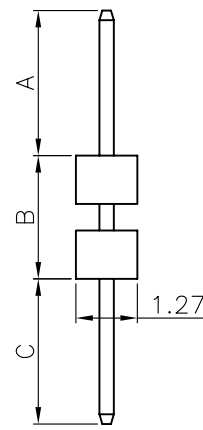
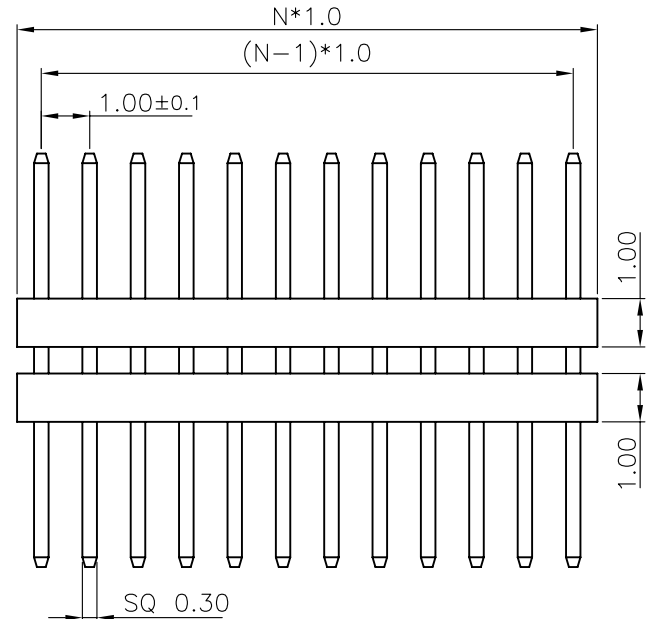

NOTES:

- MATERIAL
 - INSULATOR:THERMOPLASTIC(UL 94V-0).
 - CONTACT MATERIAL:COPPER ALLOY.
- SPECIFICATION
 - CURRENT RATING:1.0 Amp.
 - INSULATION RESISTANCE:500MΩ Min.
 - DIELECTRIC WITHSTANDING:600VAC.
 - CONTACT RESISTANCE:20mΩ Max.
 - OPERATING TEMPERATURE:-40°C TO +105°C.

- PART NUMBER: DS1031-18
- PRODUCT NUMBER CODE:

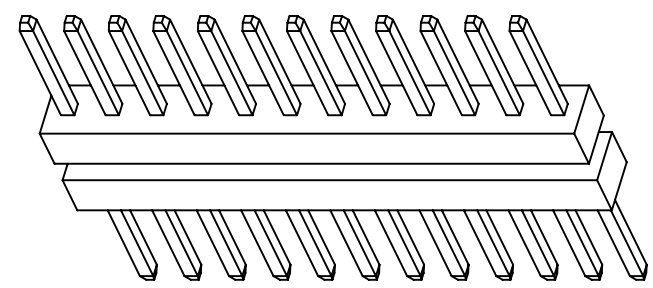
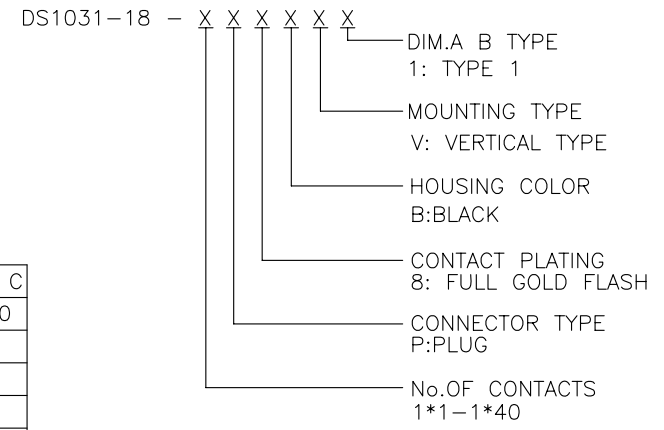

TYPE	DIM A	DIM B	DIM C
1	3.00	2.55	3.00
2			
3			
4			
5			
6			
7			
8			
9			
10			

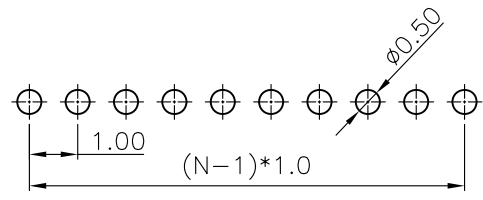

RECOMMEND PCB LAYOUT(TOLERANCE=±0.05)

GENERAL TOLERANCE		ANGLE TOLERANCE		PROJECTION		TITLE	SINGLE ROW PIN HEADER
X.	±0.60	X.	±5°	UNITS	mm	PITCH 1.00mm STACK V/T TYPE	
.X	±0.38	.X	±3°	SHEET SIZE	A4	SERIES	DS1031-18 SERIES
.XX	±0.25	.XX	±2°	晨翔电子有限公司 CONNFLY CONNFLY ELECTRONIC CO. LTD			
DRAWING TYPE		CUSTOMER					
SCALE	1:1	SHEET	1 OF 1				
DRAWING NO.		C-DS1031-18-XXXXXX					

REV.	DESCRIPTION	DRAWN	CHECKED	APPROVED
A	NEW RELEASE	YCH 03/24/09	~	

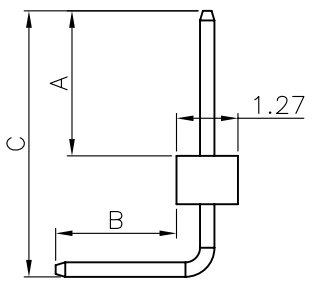
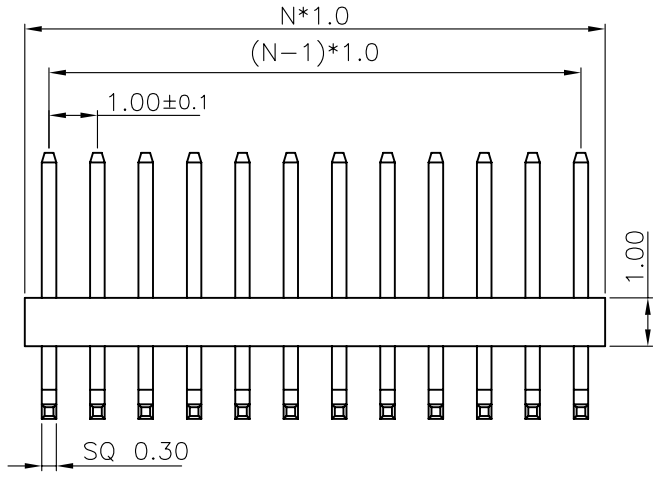

NOTES:

- MATERIAL
 - INSULATOR:THERMOPLASTIC(UL 94V-0).
 - CONTACT MATERIAL:COPPER ALLOY.
- SPECIFICATION
 - CURRENT RATING:1.0 Amp.
 - INSULATION RESISTANCE:500MΩ Min.
 - DIELECTRIC WITHSTANDING:600VAC.
 - CONTACT RESISTANCE:20mΩ Max.
 - OPERATING TEMPERATURE:-40°C TO+105°C.

- PART NUMBER: DS1031-19
- PRODUCT NUMBER CODE:

DS1031-19 - X X X X X X

- DIM.A B TYPE
1: TYPE 1
- MOUNTING TYPE
R: RIGHT ANGLE TYPE
- HOUSING COLOR
B:BLACK
- CONTACT PLATING
8: FULL GOLD FLASH
- CONNECTOR TYPE
P:PLUG
- No.OF CONTACTS
1*1-1*40

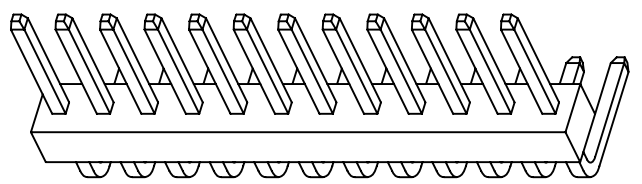

TYPE	DIM A	DIM B	DIM C
1	3.00	2.50	5.50
2			
3			
4			
5			
6			
7			
8			
9			
10			

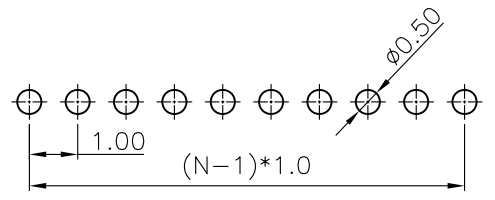

RECOMMEND PCB LAYOUT(TOLERANCE=±0.05)

GENERAL TOLERANCE		ANGLE TOLERANCE		PROJECTION		TITLE	SINGLE ROW PIN HEADER
X.	±0.60	X.	±5°	UNITS	mm		PITCH 1.00mm R/A TYPE
.X	±0.38	.X	±3°	SHEET SIZE	A4	SERIES	DS1031-19 SERIES
.XX	±0.25	.XX	±2°				
DRAWING TYPE		CUSTOMER		晨翔电子有限公司 CONNFLY CONNFLY ELECTRONIC CO. LTD			
SCALE	1:1	SHEET	1 OF 1				
DRAWING NO.	C-DS1031-19-XXXXXX						

REV.	DESCRIPTION	DRAWN	CHECKED	APPROVED
A	NEW RELEASE	YCH 03/24/09	~	

NOTES:

- MATERIAL
 - INSULATOR:THERMOPLASTIC(UL 94V-0).
 - CONTACT MATERIAL:COPPER ALLOY.
- SPECIFICATION
 - CURRENT RATING:1.0 Amp.
 - INSULATION RESISTANCE:500MΩ Min.
 - DIELECTRIC WITHSTANDING:600VAC.
 - CONTACT RESISTANCE:20mΩ Max.
 - OPERATING TEMPERATURE:-40°C TO+105°C.

- PART NUMBER: DS1031-20
- PRODUCT NUMBER CODE:

DS1031-20 - X X X X X X

- X — DIM.A B TYPE
- X — 1: TYPE 1
- X — MOUNTING TYPE
- X — V: VERTICAL TYPE
- X — HOUSING COLOR
- X — B:BLACK
- X — CONTACT PLATING
- X — 8: FULL GOLD FLASH
- X — CONNECTOR TYPE
- X — P:PLUG
- X — No.OF CONTACTS
- X — 2*2-2*40

TYPE	DIM A	DIM B
1	1.90	1.90
2		
3		
4		
5		
6		
7		
8		
9		
10		

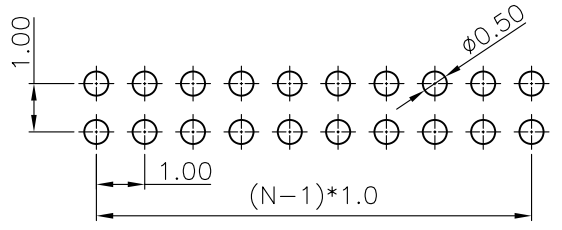
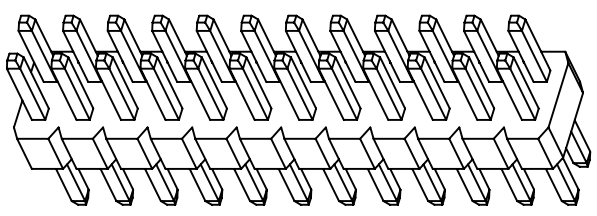
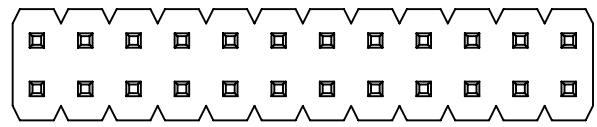
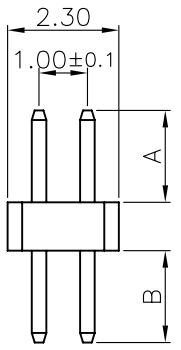
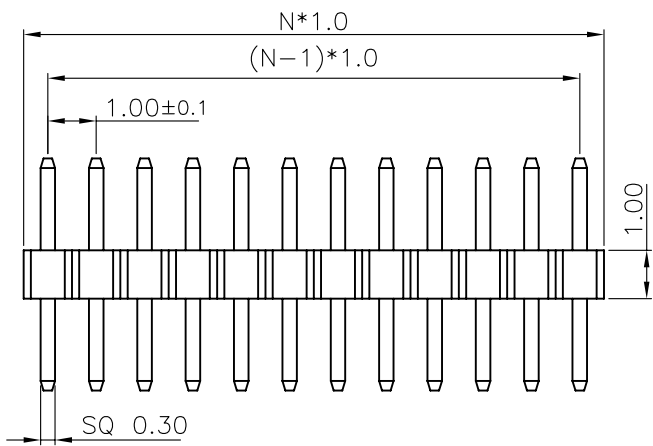

RECOMMEND PCB LAYOUT(TOLERANCE=±0.05)

GENERAL TOLERANCE		ANGLE TOLERANCE		PROJECTION		TITLE	DUAL ROW PIN HEADER	
X.	±0.60	X.	±5°	UNITS	mm	PITCH 1.00mm V/T TYPE		
.X	±0.38	.X	±3°	SHEET SIZE	A4	SERIES	DS1031-20 SERIES	
.XX	±0.25	.XX	±2°	晨翔电子有限公司 CONNFLY CONNFLY ELECTRONIC CO. LTD				
DRAWING TYPE		CUSTOMER						
SCALE	1:1	SHEET	1 OF 1					
DRAWING NO.		C-DS1031-20-XXXXXX						

REV.	DESCRIPTION	DRAWN	CHECKED	APPROVED
A	NEW RELEASE	YCH 03/24/09	~	

NOTES:

- MATERIAL
 - INSULATOR:THERMOPLASTIC(UL 94V-0).
 - CONTACT MATERIAL:COPPER ALLOY.
- SPECIFICATION
 - CURRENT RATING:1.0 Amp.
 - INSULATION RESISTANCE:500MΩ Min.
 - DIELECTRIC WITHSTANDING:600VAC.
 - CONTACT RESISTANCE:20mΩ Max.
 - OPERATING TEMPERATURE:-40°C TO+105°C.

3. PART NUMBER: DS1031-25

4. PRODUCT NUMBER CODE:

DS1031-25 - X X X X X X

- DIM.A B TYPE
1: TYPE 1
- MOUNTING TYPE
V: VERTICAL TYPE
- HOUSING COLOR
B:BLACK
- CONTACT PLATING
8: FULL GOLD FLASH
- CONNECTOR TYPE
P:PLUG
- No.OF CONTACTS
2*2-2*40

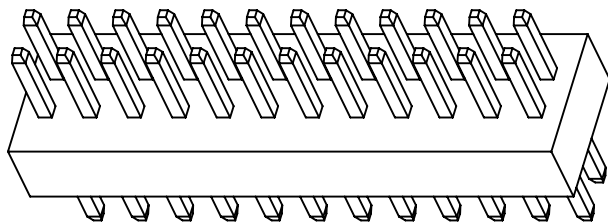
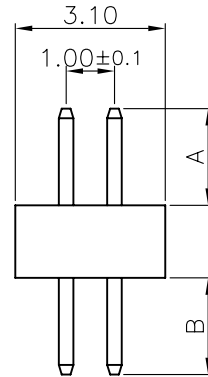
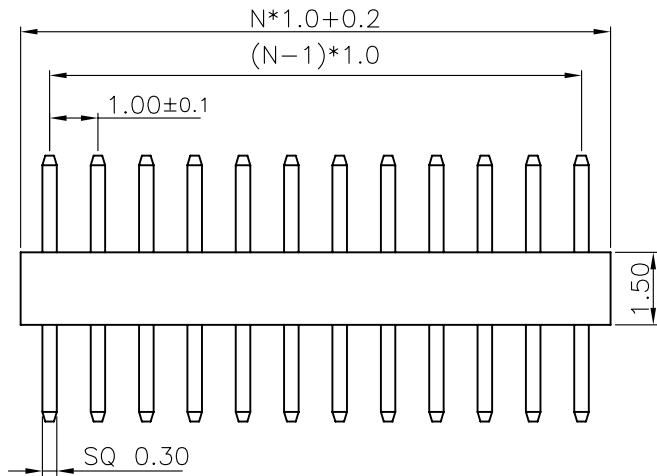

TYPE	DIM A	DIM B
1	2.00	2.00
2		
3		
4		
5		
6		
7		
8		
9		
10		

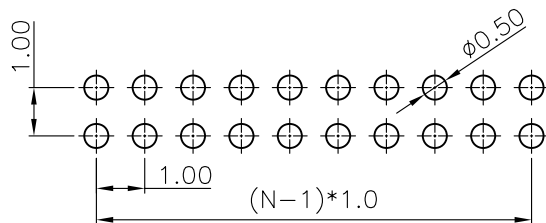

RECOMMEND PCB LAYOUT(TOLERANCE=±0.05)

GENERAL TOLERANCE		ANGLE TOLERANCE		PROJECTION	TITLE
X.	±0.60	X.	±5°	mm	DUAL ROW PIN HEADER
.X	±0.38	.X	±3°	A4	PITCH 1.0mm V/T TYPE
.XX	±0.25	.XX	±2°	SHEET SIZE	SERIES DS1031-25 SERIES
DRAWING TYPE		CUSTOMER		 晨翔电子有限公司 CONNFLY CONNFLY ELECTRONIC CO. LTD	
SCALE		1:1 SHEET 1 OF 1			
DRAWING NO.		C-DS1031-25-XXXXXX			

REV.	DESCRIPTION	DRAWN	CHECKED	APPROVED
A	NEW RELEASE	YCH 03/24/09	~	

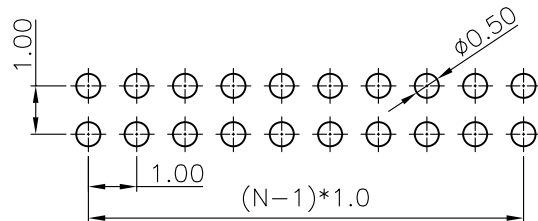
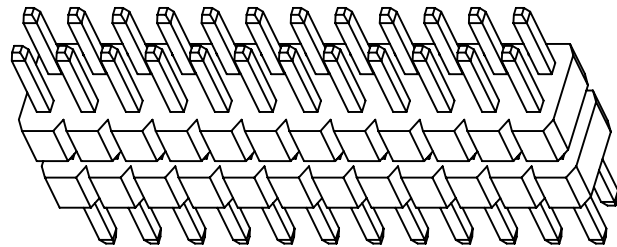
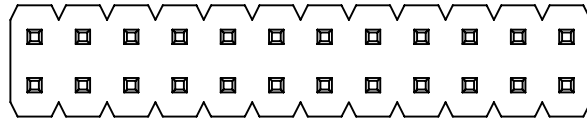
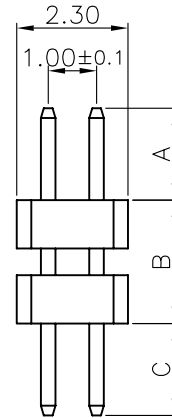
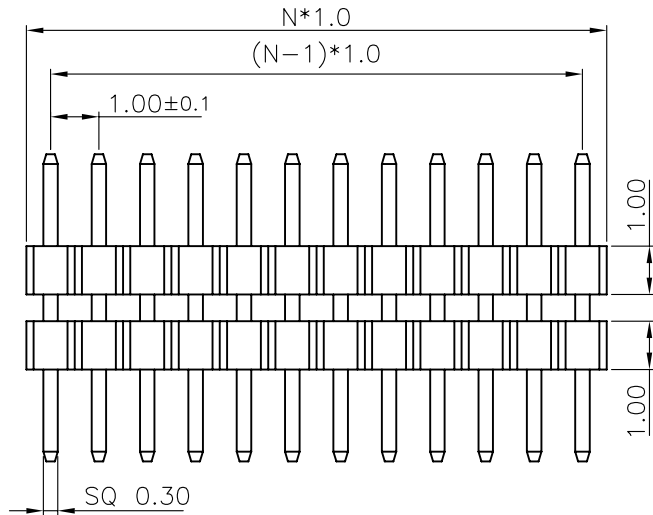

RECOMMEND PCB LAYOUT(TOLERANCE=±0.05)

NOTES:

- MATERIAL
 - INSULATOR:THERMOPLASTIC(UL 94V-0).
 - CONTACT MATERIAL:COPPER ALLOY.
- SPECIFICATION
 - CURRENT RATING:1.0 Amp.
 - INSULATION RESISTANCE:500MΩ Min.
 - DIELECTRIC WITHSTANDING:600VAC.
 - CONTACT RESISTANCE:20mΩ Max.
 - OPERATING TEMPERATURE:-40°C TO+105°C.
- PART NUMBER: DS1031-21
- PRODUCT NUMBER CODE:

DS1031-21 - X X X X X X
 DIM.A B TYPE
 1: TYPE 1
 MOUNTING TYPE
 V: VERTICAL TYPE
 HOUSING COLOR
 B:BLACK
 CONTACT PLATING
 8: FULL GOLD FLASH
 CONNECTOR TYPE
 P:PLUG
 No.OF CONTACTS
 2*2-2*40

TYPE	DIM A	DIM B	DIM C
1	1.90	2.55	1.90
2			
3			
4			
5			
6			
7			
8			
9			
10			

GENERAL TOLERANCE		ANGLE TOLERANCE		PROJECTION		TITLE	DUAL ROW PIN HEADER	
X.	±0.60	X.	±5°	UNITS	mm	PITCH 1.0mm STACK V/T TYPE		
.X	±0.38	.X	±3°	SHEET SIZE	A4	SERIES	DS1031-21 SERIES	
.XX	±0.25	.XX	±2°	晨翔电子有限公司 CONNFLY CONNFLY ELECTRONIC CO. LTD				
DRAWING TYPE		CUSTOMER						
SCALE	1:1	SHEET	1 OF 1					
DRAWING NO.		C-DS1031-21-XXXXXX						

REV.	DESCRIPTION	DRAWN	CHECKED	APPROVED
A	NEW RELEASE	YCH 03/24/09	~	

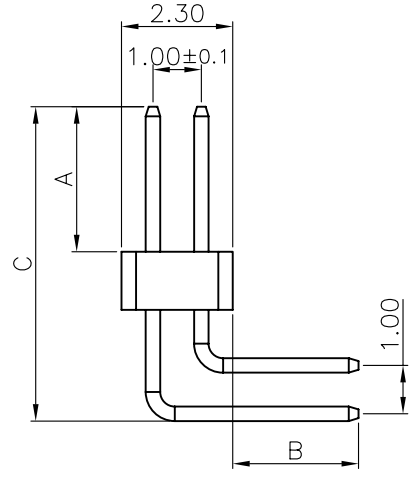
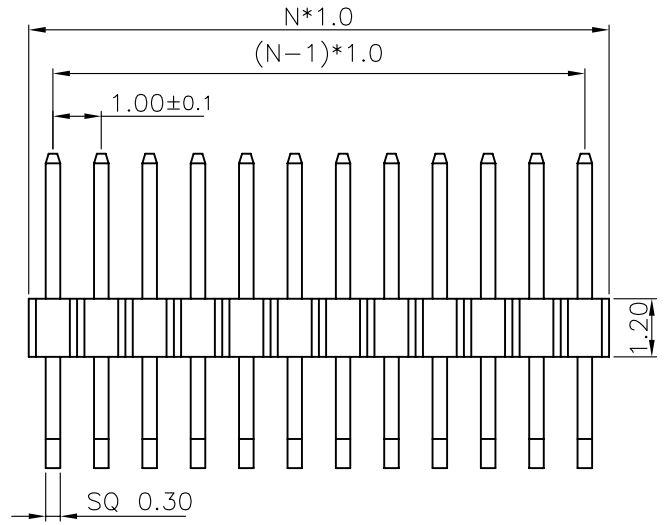

NOTES:

- MATERIAL
 - INSULATOR:THERMOPLASTIC(UL 94V-0).
 - CONTACT MATERIAL:COPPER ALLOY.
- SPECIFICATION
 - CURRENT RATING:1.0 Amp.
 - INSULATION RESISTANCE:500MΩ Min.
 - DIELECTRIC WITHSTANDING:600VAC.
 - CONTACT RESISTANCE:20mΩ Max.
 - OPERATING TEMPERATURE:-40°C TO+105°C.

- PART NUMBER: DS1031-22
- PRODUCT NUMBER CODE:

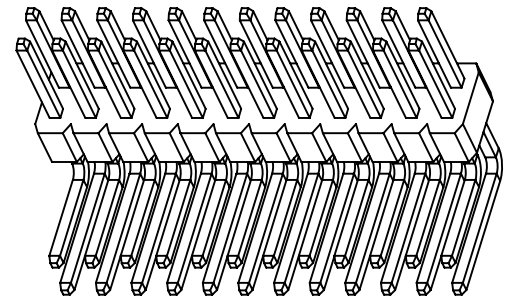
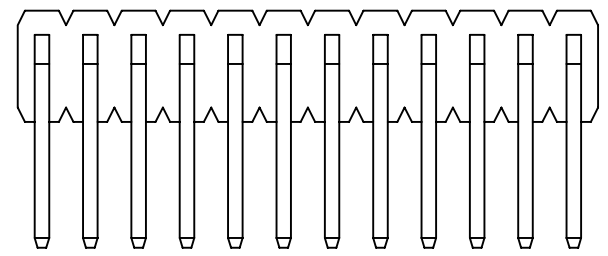
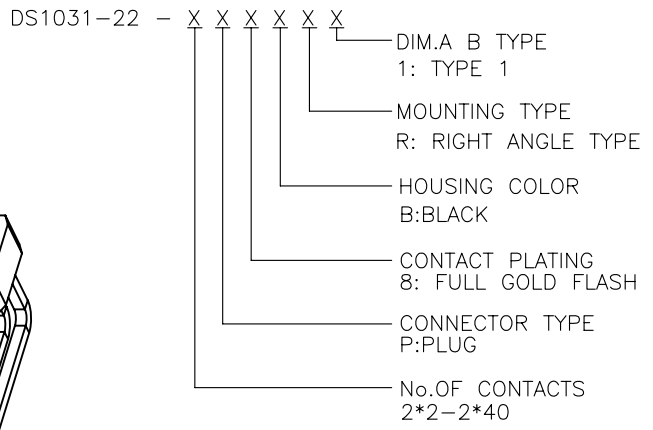

TYPE	DIM A	DIM B	DIM C
1	3.00	2.60	6.50
2			
3			
4			
5			

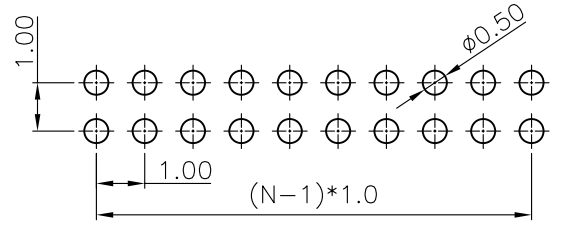

RECOMMEND PCB LAYOUT(TOLERANCE=±0.05)

GENERAL TOLERANCE		ANGLE TOLERANCE		PROJECTION		TITLE	DUAL ROW PIN HEADER	
X.	±0.60	X.	±5°	UNITS	mm		PITCH 1.0mm V/T TYPE	
.X	±0.38	.X	±3°	SHEET SIZE	A4	SERIES	DS1031-22 SERIES	
.XX	±0.25	.XX	±2°	晨翔电子有限公司 CONNFLY CONNFLY ELECTRONIC CO. LTD				
DRAWING TYPE		CUSTOMER						
SCALE	1:1	SHEET	1 OF 1					
DRAWING NO.		C-DS1031-22-XXXXXX						

REV.	DESCRIPTION	DRAWN	CHECKED	APPROVED
A	NEW RELEASE	YCH 03/24/09	~	

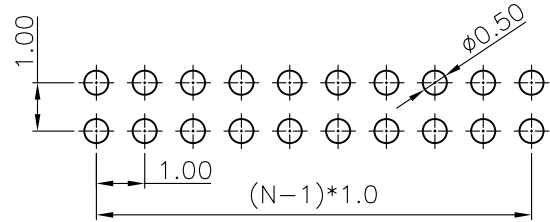
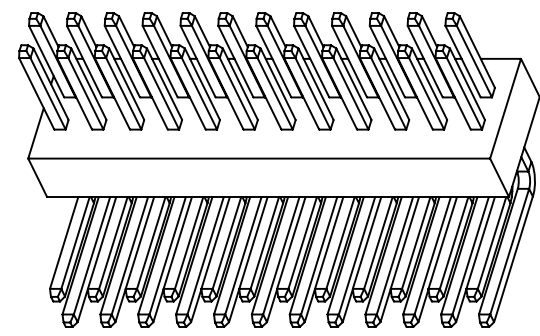
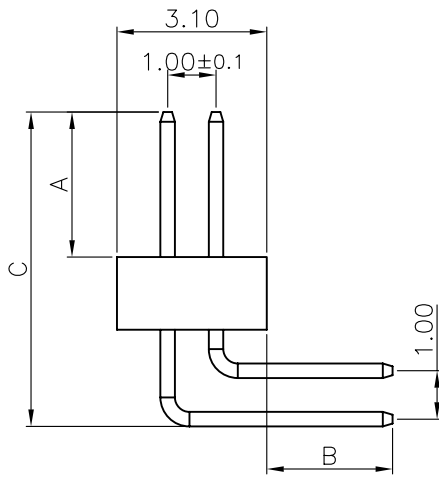
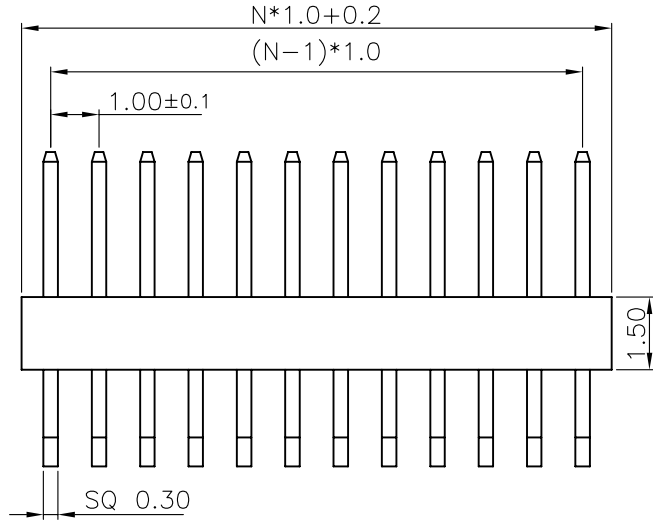

RECOMMEND PCB LAYOUT(TOLERANCE=±0.05)

NOTES:

- MATERIAL
 - INSULATOR:THERMOPLASTIC(UL 94V-0).
 - CONTACT MATERIAL:COPPER ALLOY.
- SPECIFICATION
 - CURRENT RATING:1.0 Amp.
 - INSULATION RESISTANCE:500MΩ Min.
 - DIELECTRIC WITHSTANDING:600VAC.
 - CONTACT RESISTANCE:20mΩ Max.
 - OPERATING TEMPERATURE:-40°C TO+105°C.

3. PART NUMBER: DS1031-26

4. PRODUCT NUMBER CODE:

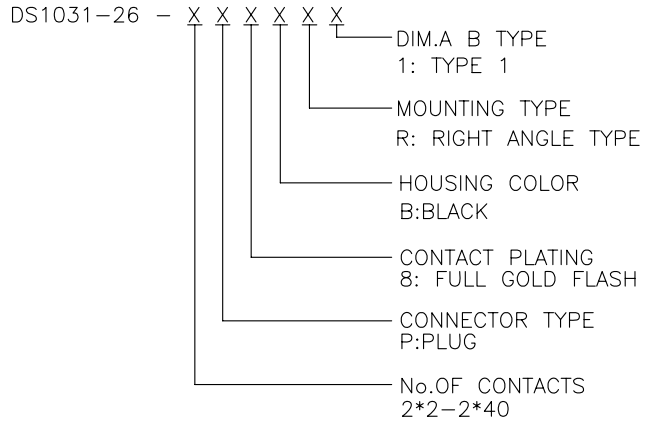

TYPE	DIM A	DIM B	DIM C
1	3.00	2.60	6.50
2			
3			
4			
5			
6			
7			
8			
9			

GENERAL TOLERANCE	ANGLE TOLERANCE
X. ±0.60	X. ±5°
.X ±0.38	.X ±3°
.XX ±0.25	.XX ±2°

PROJECTION		TITLE	DUAL ROW PIN HEADER
UNITS	mm		PITCH 1.0mm R/A TYPE
SHEET SIZE	A4	SERIES	DS1031-26 SERIES

DRAWING TYPE	CUSTOMER		
SCALE	1:1	SHEET	1 OF 1
DRAWING NO.	C-DS1031-26-XXXXXX		

晨翔电子有限公司
CONNFLY CONNFLY ELECTRONIC CO. LTD

REV.	DESCRIPTION	DRAWN	CHECKED	APPROVED
A	NEW RELEASE	YCH 03/24/09	~	

NOTES:

- MATERIAL
 - INSULATOR:THERMOPLASTIC(UL 94V-0).
 - CONTACT MATERIAL:COPPER ALLOY.
- SPECIFICATION
 - CURRENT RATING:1.0 Amp.
 - INSULATION RESISTANCE:500MΩ Min.
 - DIELECTRIC WITHSTANDING:600VAC.
 - CONTACT RESISTANCE:20mΩ Max.
 - OPERATING TEMPERATURE:-40°C TO+105°C.

3. PART NUMBER: DS1031-23

4. PRODUCT NUMBER CODE:

DS1031-23 - X X X X X X

- DIM.A B TYPE
1: TYPE 1
- MOUNTING TYPE
S: SMT TYPE
- HOUSING COLOR
B:BLACK
- CONTACT PLATING
8: FULL GOLD FLASH
- CONNECTOR TYPE
P:PLUG
- No.OF CONTACTS
2*2-2*40

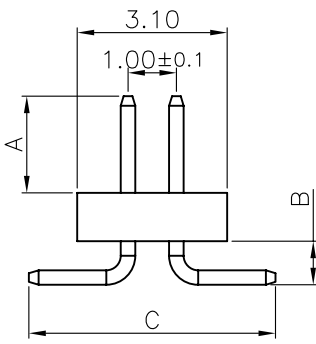

TYPE	DIM A	DIM B	DIM C
1	2.00	0.90	5.10
2			
3			
4			
5			
6			
7			
8			

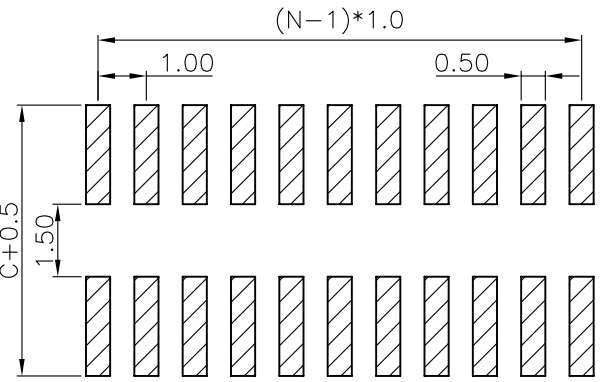
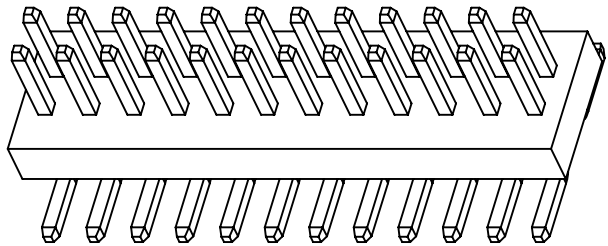
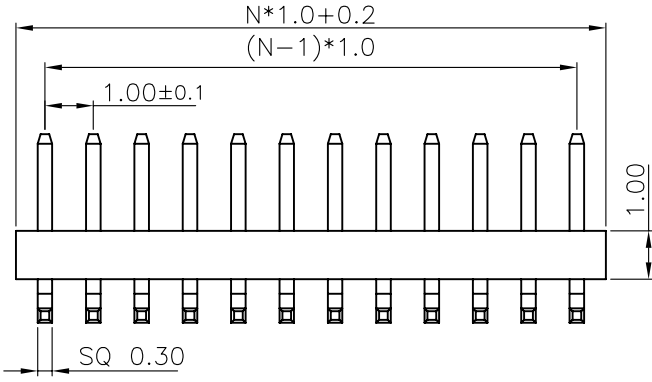
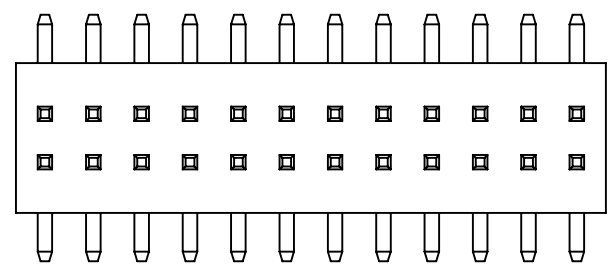

RECOMMEND PCB LAYOUT(TOLERANCE=±0.05)

GENERAL TOLERANCE	ANGLE TOLERANCE
X. ±0.60	X. ±5°
.X ±0.38	.X ±3°
.XX ±0.25	.XX ±2°

PROJECTION		TITLE	DUAL ROW PIN HEADER
UNITS	mm		PITCH 1.0mm SMT TYPE
SHEET SIZE	A4	SERIES	DS1031-23 SERIES

DRAWING TYPE	CUSTOMER
SCALE	1:1 SHEET 1 OF 1
DRAWING NO.	C-DS1031-23-XXXXXX

晨翔电子有限公司
CONNFLY CONNFLY ELECTRONIC CO. LTD

REV.	DESCRIPTION	DRAWN	CHECKED	APPROVED
A	NEW RELEASE	YCH 03/24/09	~	

NOTES:

- MATERIAL
 - INSULATOR:THERMOPLASTIC(UL 94V-0).
 - CONTACT MATERIAL:COPPER ALLOY.
- SPECIFICATION
 - CURRENT RATING:1.0 Amp.
 - INSULATION RESISTANCE:500MΩ Min.
 - DIELECTRIC WITHSTANDING:600VAC.
 - CONTACT RESISTANCE:20mΩ Max.
 - OPERATING TEMPERATURE:-40°C TO+105°C.

3. PART NUMBER: DS1031-24

4. PRODUCT NUMBER CODE:

DS1031-24 - X X X X X X

- DIM.A B TYPE
1: TYPE 1
- MOUNTING TYPE
S: SMT TYPE
- HOUSING COLOR
B:BLACK
- CONTACT PLATING
8: FULL GOLD FLASH
- CONNECTOR TYPE
P:PLUG
- No.OF CONTACTS
2*2-2*40

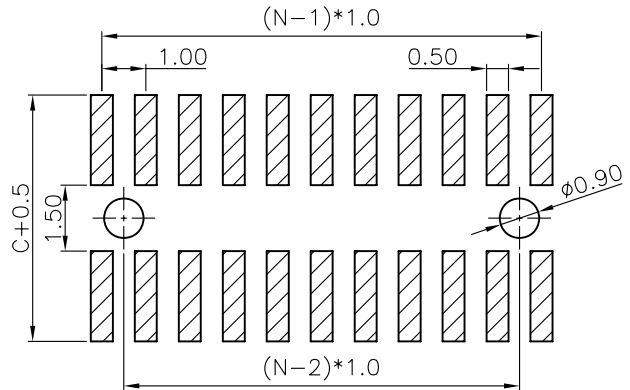
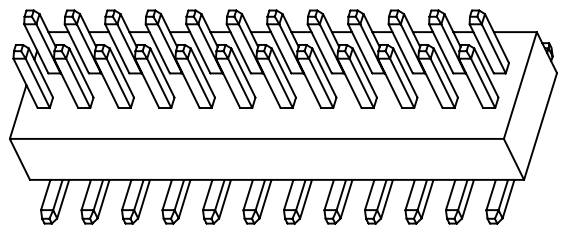
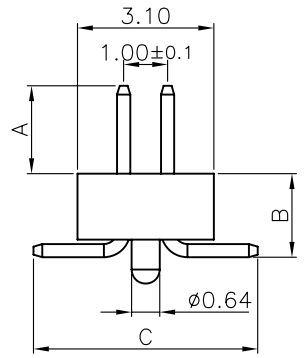
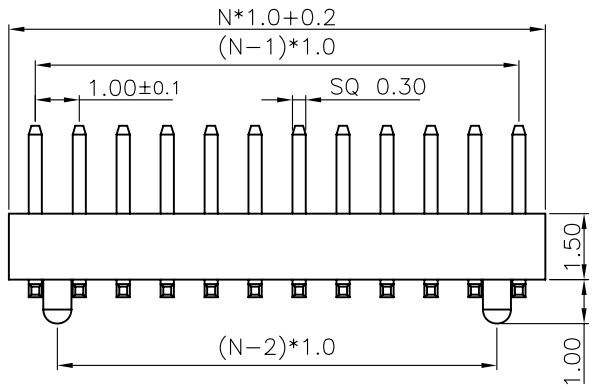
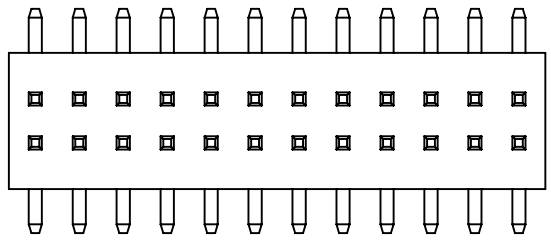

TYPE	DIM A	DIM B	DIM C
1	2.00	1.90	5.10
2			
3			
4			
5			
6			
7			
8			

RECOMMEND PCB LAYOUT(TOLERANCE=±0.05)

GENERAL TOLERANCE		ANGLE TOLERANCE	
X.	±0.60	X.	±5°
.X	±0.38	.X	±3°
.XX	±0.25	.XX	±2°

DRAWING TYPE	CUSTOMER		
SCALE	1:1	SHEET	1 OF 1
DRAWING NO.	C-DS1031-24-XXXXXX		

PROJECTION	TITLE	DUAL ROW PIN HEADER	
mm		PITCH 1.0mm SMT TYPE W/ POST	
SHEET SIZE	A4	SERIES	DS1031-24 SERIES



晨翔电子有限公司
CONNFLY CONNFLY ELECTRONIC CO. LTD

REV.	DESCRIPTION	DRAWN	CHECKED	APPROVED
A	NEW RELEASE	YCH 03/24/09	~	

NOTES:

- MATERIAL
 - INSULATOR:THERMOPLASTIC(UL 94V-0).
 - CONTACT MATERIAL:COPPER ALLOY.
- SPECIFICATION
 - CURRENT RATING:1.0 Amp.
 - INSULATION RESISTANCE:500MΩ Min.
 - DIELECTRIC WITHSTANDING:600VAC.
 - CONTACT RESISTANCE:20mΩ Max.
 - OPERATING TEMPERATURE:-40°C TO+105°C.
- PART NUMBER: DS1031-27
- PRODUCT NUMBER CODE:
DS1031-27 - X X X X X X X X

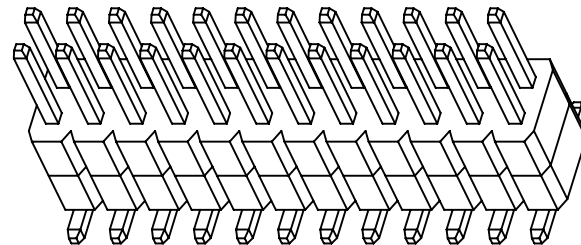
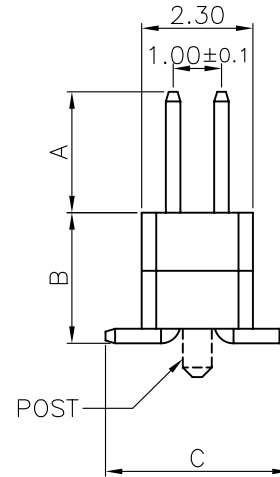
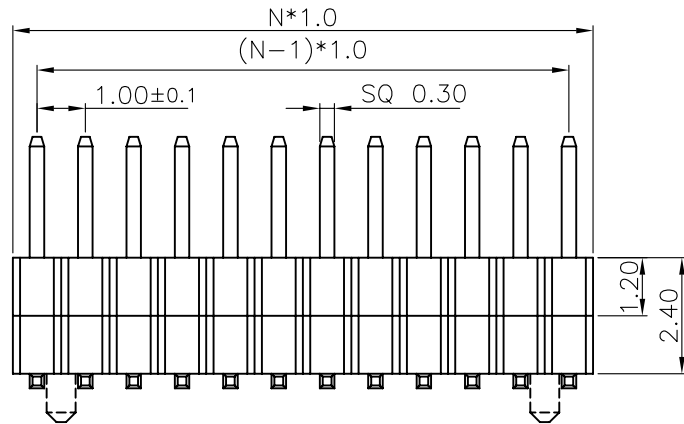
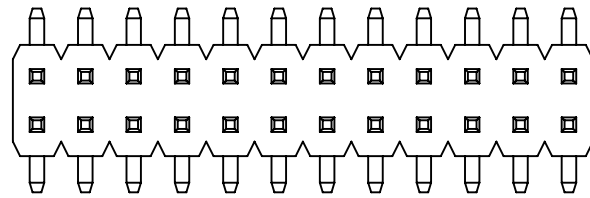
- POST SUPPORT
S:W/ POST
X:W/O POST
- PACKING TYPE
T:TRAY
R:TAPE ON REEL
B:TUBE
- PICK UP SUPPORT
S:W/ PICK UP
X:W/O PICK UP
- DIM.A B TYPE
1: TYPE 1
- MOUNTING TYPE
S: SMT TYPE
- HOUSING COLOR
B:BLACK
- CONTACT PLATING
8: FULL GOLD FLASH
- CONNECTOR TYPE
P:PLUG
- No.OF CONTACTS
2*2-2*40



TYPE	DIM A	DIM B	DIM C
1	2.50	2.70	3.80
2			
3			
4			
5			
6			
7			
8			

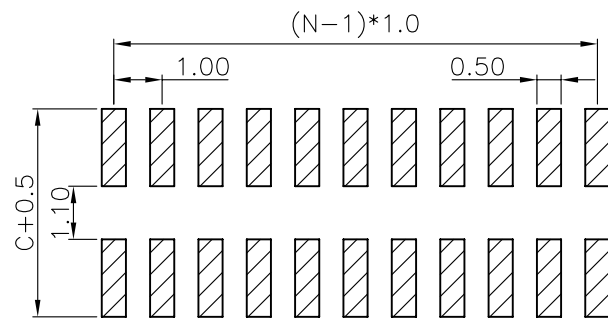

RECOMMEND PCB LAYOUT(TOLERANCE=±0.05)

GENERAL TOLERANCE		ANGLE TOLERANCE	
X.	±0.60	X.	±5°
.X	±0.38	.X	±3°
.XX	±0.25	.XX	±2°

DRAWING TYPE	CUSTOMER		
SCALE	1:1	SHEET	1 OF 1
DRAWING NO.	C-DS1031-27-XXXXXXXX		

PROJECTION	TITLE	DUAL ROW PIN HEADER	
UNITS	mm	PITCH 1.0mm STACK SMT TYPE	
SHEET SIZE	A4	SERIES	DS1031-27 SERIES

晨翔电子有限公司
CONNFLY CONNFLY ELECTRONIC CO. LTD

REV.	DESCRIPTION	DRAWN	CHECKED	APPROVED
A	NEW RELEASE	YCH 03/24/09	~	

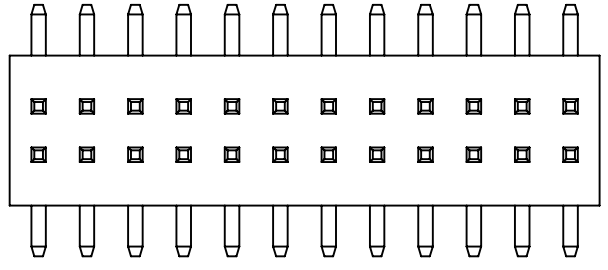

3D MODEL(SCLAE 1:2)

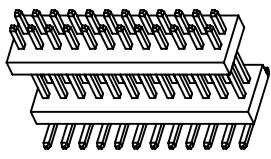

NOTES:

- MATERIAL
 - INSULATOR:THERMOPLASTIC(UL 94V-0).
 - CONTACT MATERIAL:COPPER ALLOY.
- SPECIFICATION
 - CURRENT RATING:1.0 Amp.
 - INSULATION RESISTANCE:500MΩ Min.
 - DIELECTRIC WITHSTANDING:600VAC.
 - CONTACT RESISTANCE:20mΩ Max.
 - OPERATING TEMPERATURE:-40°C TO+105°C.

3. PART NUMBER: DS1031-28

4. PRODUCT NUMBER CODE:

DS1031-28 - X X X X X X X X X

- POST SUPPORT
S:W/ POST
X:W/O POST
- PACKING TYPE
T:TRAY
R:TAPE ON REEL
B:TUBE
- PICK UP SUPPORT
S:W/ PICK UP
X:W/O PICK UP
- DIM.A B TYPE
1: TYPE 1
2: TYPE 2
3: TYPE 3
- MOUNTING TYPE
S: SMT TYPE
- HOUSING COLOR
B:BLACK
- CONTACT PLATING
8: FULL GOLD FLASH
- CONNECTOR TYPE
P:PLUG
- No.OF CONTACTS
2*2-2*40

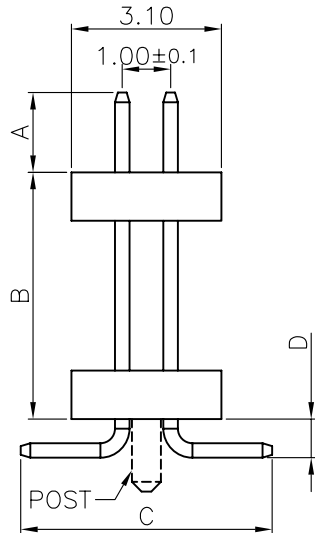
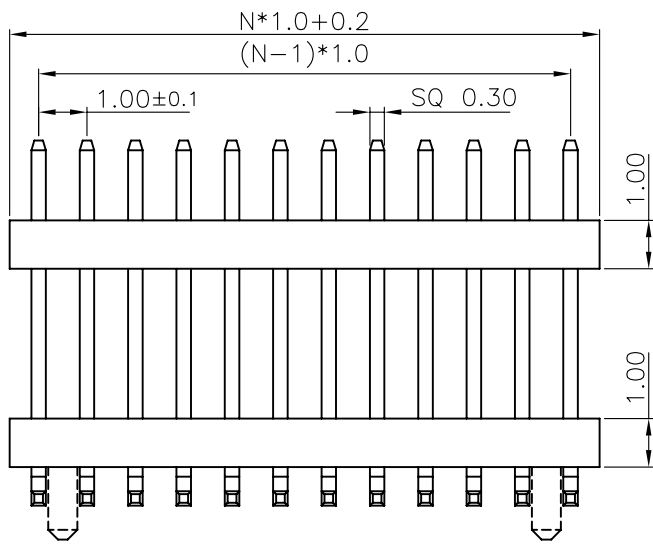

TYPE	DIM A	DIM B	DIM C	DIM D
1	1.65	5.10	5.20	0.80
2	1.65	6.73	5.20	0.80
3	1.65	9.00	5.20	0.80
4				
5				
6				

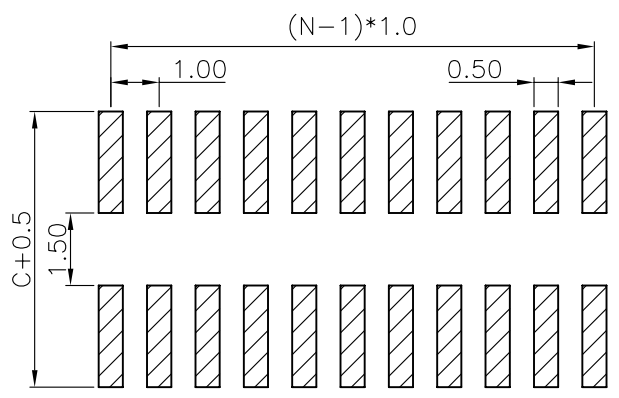

RECOMMEND PCB LAYOUT(TOLERANCE=±0.05)

GENERAL TOLERANCE	ANGLE TOLERANCE	PROJECTION		TITLE
X. ±0.60	X. ±5°	UNITS	mm	DUAL ROW PIN HEADER
.X ±0.38	.X ±3°	SHEET SIZE	A4	PITCH 1.00mm STACK SMT TYPE
.XX ±0.25	.XX ±2°			SERIES DS1031-28 SERIES

DRAWING TYPE	CUSTOMER
SCALE	1:1 SHEET 1 OF 1
DRAWING NO.	C-DS1031-28-XXXXXXXX

PROJECTION		TITLE	DUAL ROW PIN HEADER
UNITS	mm		PITCH 1.00mm STACK SMT TYPE
SHEET SIZE	A4	SERIES	DS1031-28 SERIES

晨翔电子有限公司
CONNFLY CONNFLY ELECTRONIC CO. LTD