

# Not for new design. Please use new F622 Series

General Purpose Metallized Polyester Film Capacitors

**RSB Series, 5 – 37.5 mm Lead Spacing, 50 – 630 VDC**



## Overview

The RSB Series is constructed of metallized stacked polyester film capacitor with radial leads of tinned wire. Radial leads are electrically welded to the contact metal layer on the ends of the capacitor winding. The capacitor is encapsulated in a self-extinguishing material meeting the requirements of UL 94 V-0.

## Applications

Typical applications include high performance, high temperature blocking, coupling, decoupling, bypassing and interference suppression in low voltage applications such as automotive. Not for use with the mains.

## Benefits

- Voltage range: 50 – 630 VDC
- Capacitance range: 0.001 – 2.2  $\mu$ F
- Lead spacing: 5 – 37.5 mm
- Capacitance tolerance:  $\pm$ 20%,  $\pm$ 10% standard,  $\pm$ 5% on request
- Climatic category: 55/125/56
- Tape and reel packaging in accordance with IEC 60286-2
- RoHS Compliant and lead-free terminations
- Operating temperature range of -55°C to +125°C
- Designed for high performance, high temperature applications

## Ordering Information

RSB	D	C	3100	AA	00	J
Series	Rated Voltage (VDC)	Lead Spacing (mm)	Capacitance Code (pF)	Lead and Packaging Code	Internal Use	Capacitance Tolerance
Metallized Polyester	C = 50 D = 63 E = 100 I = 250 M = 400 W = 500 P = 630	C = 5.0	Digits 2-4 indicate the first three digits of the capacitance value. First digit indicates the number of zeros to be added.	See Ordering Options Table	00,10 (Standard)	J = $\pm$ 5% K = $\pm$ 10% M = $\pm$ 20%

## Ordering Options Table

Lead Spacing Nominal (mm)	Type of Leads and Packaging	Lead Length (mm)	Lead and Packaging Code
5	Standard Lead and Packaging Options		
	Bulk (Bag)–Short Leads	4 +1.5/-0	SE
	Ammo Pack	H <sub>0</sub> = 18.5 +/-0.5	DQ
	Other Lead and Packaging Options		
	Bulk (Bag)–Long Leads	17 +2/-1	Z3
	Tape & Reel (Large Reel)	H <sub>0</sub> = 18.5 +/-0.5	CK

# Not for new design. Please use new F622 Series

Film Through-Hole Capacitors

General Purpose Metallized Polyester Film Capacitors – RSB Series, 5 – 37.5 mm Lead Spacing, 50 – 630 VDC



## Dimensions – Millimeters

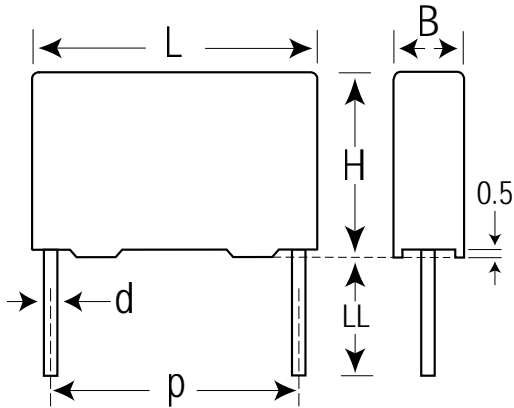

p		B		H		L		d	
Nominal	Tolerance	Nominal	Tolerance	Nominal	Tolerance	Nominal	Tolerance	Nominal	Tolerance
5.0	+/-0.4	2.5	Maximum	6.5	Maximum	7.2	Maximum	0.6	+/-0.05
5.0	+/-0.4	3.5	Maximum	7.5	Maximum	7.2	Maximum	0.6	+/-0.05
5.0	+/-0.4	4.5	Maximum	9.5	Maximum	7.2	Maximum	0.6	+/-0.05
5.0	+/-0.4	5.0	Maximum	10.0	Maximum	7.2	Maximum	0.6	+/-0.05
5.0	+/-0.4	6.0	Maximum	11.0	Maximum	7.2	Maximum	0.6	+/-0.05

**Note: See Ordering Options Table for lead length (LL) options.**

# Not for new design. Please use new F622 Series

Film Through-Hole Capacitors

General Purpose Metallized Polyester Film Capacitors – RSB Series, 5 – 37.5 mm Lead Spacing, 50 – 630 VDC



## Performance Characteristics

Capacitance Tolerance	±20%, ±10%, ±5% on request			
Category Temperature Range	-55°C to 125°C			
Voltage Derating	Above +85°C DC and AC voltage derating is 1.25%/°C			
Rated Temperature	+85°C			
Climatic Category	-55 to +125°C			
	Average relative humidity ≤ 75%			
	RH = 95% for 30 days per year			
	RH = 85% for further days limited by average value per year			
Test Voltage	1.6 x V <sub>R</sub> VDC for 2 seconds			
Capacitance Drift	Maximum 3% after a 2 year storage period at a temperature of +10°C to +40°C and a relative humidity of 40% to 60%			
Reliability	Operational life > 200,000 hours			
	Failure rate < 3 FIT, T = +40°C, V = 0.5 x V <sub>R</sub>			
	Failure criteria: open circuit, short circuit, cap change > 10%, DF 2 times the catalog limits, IR < 50 MΩ			
Maximum Pulse Steepness	dV/dt according to Table 1. For peak voltages lower than rated voltage (V <sub>pp</sub> < V <sub>R</sub> ), the specified dV/dt can be multiplied by the factor V <sub>R</sub> /V <sub>pp</sub> .			
Temperature Coefficient	+400 (±200) ppm/°C at 1 kHz			
Self Inductance	Approximately 6 nH/cm for the total length of capacitor winding and the leads			
Dissipation Factor tanδ	Maximum Values at +23°C			
		C ≤ 0.1 μF	0.1 μF < C ≤ 1.0 μF	C > 1.0 μF
	1 kHz	0.8%	0.8%	0.8%
	10 kHz	1.2%	1.2%	1.5%
	100 kHz	2.5%		
Insulation Resistance	Measured at +20°C, according to IEC 60384-2			
	Minimum Values Between Terminals			
		C ≤ 0.33 μF	C > 0.33 μF and < 1 μF	C > 1.0 μF
	V <sub>R</sub> ≤ 100 VDC	15,000 MΩ	5,000 MΩ • μF	1,000 MΩ • μF
	V <sub>R</sub> > 100 VDC	30,000 MΩ	10,000 MΩ • μF	

## Maximum Voltage ( $V_{rms}$ ) vs. Frequency (Sinusoidal Waveform/ $T_h \leq 40^\circ C$ ) Lead Spacing 5 mm

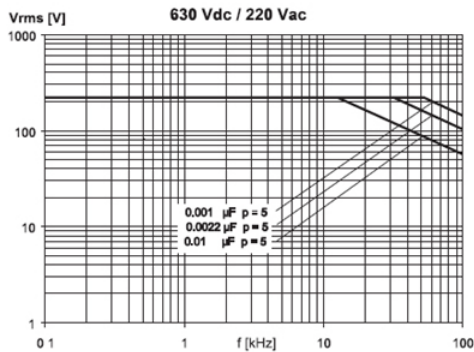
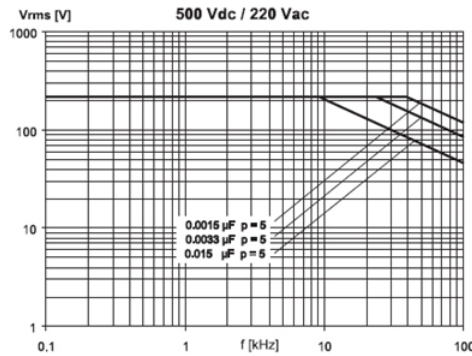
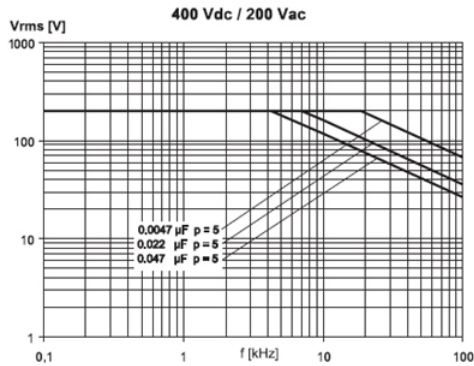
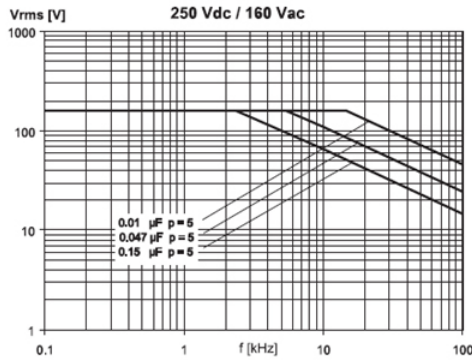
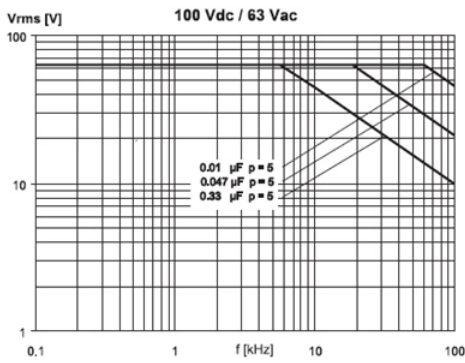
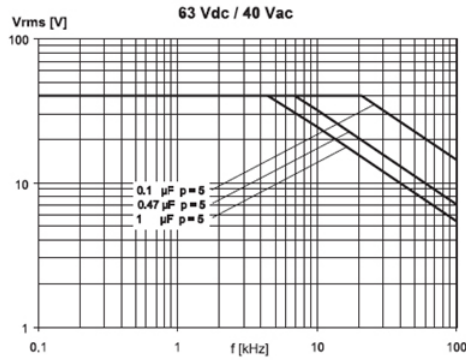
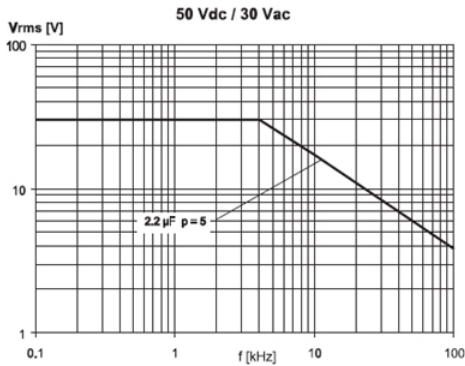

## Maximum Current (Irms) vs. Frequency (Sinusoidal Waveform/Th ≤ 40°C) Lead Spacing 5 mm

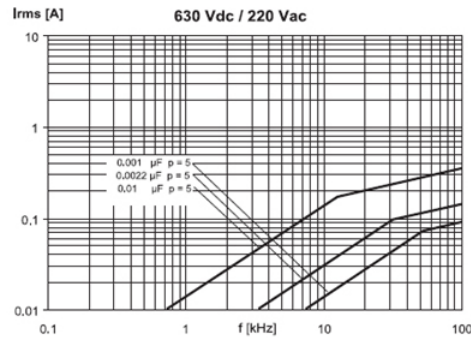
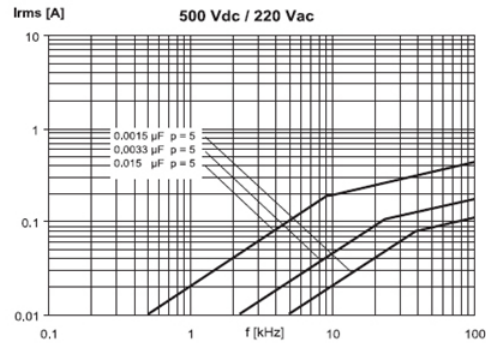
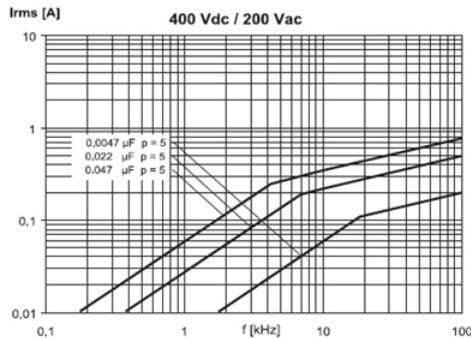
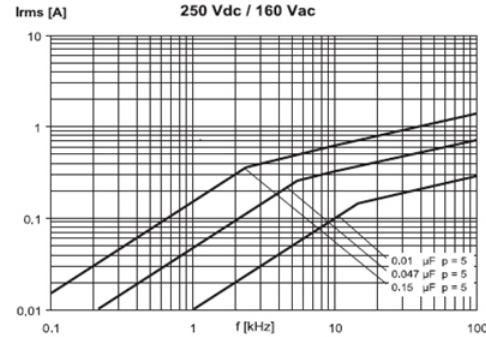
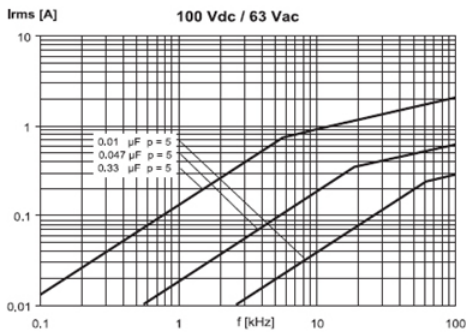
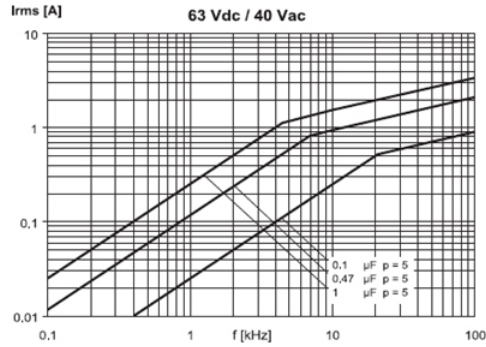
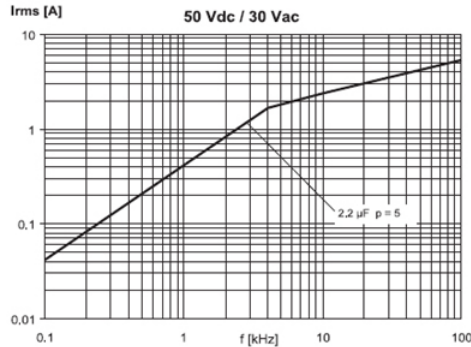

# Not for new design. Please use new F622 Series

Film Through-Hole Capacitors

General Purpose Metallized Polyester Film Capacitors – RSB Series, 5 – 37.5 mm Lead Spacing, 50 – 630 VDC



## Environmental Test Data

Damp Heat Test	Test Conditions	T = +40°C, RH = 93%, t = 56 days
	Test Criteria	$\Delta C/C \leq \pm 5\%$ , $\Delta \tan\delta \leq 0.005$ (1 kHz) IR after test 0.5 x IR min.
Endurance Test	Test Conditions	T = +100°C, U = 1.25 x (0.8 x U <sub>R</sub> )
	Test Criteria	t = 2,000 hours $\Delta C/C \leq \pm 5\%$ , $\Delta \tan\delta \leq 0.005$ (1 kHz) $\Delta \tan\delta \leq 0.010$ (100 kHz) IR after test 0.5 x IR min.

## Environmental Compliance

All KEMET MKTI capacitors are RoHS Compliant.



RoHS Compliant

# Not for new design. Please use new F622 Series

Film Through-Hole Capacitors

General Purpose Metallized Polyester Film Capacitors – RSB Series, 5 – 37.5 mm Lead Spacing, 50 – 630 VDC

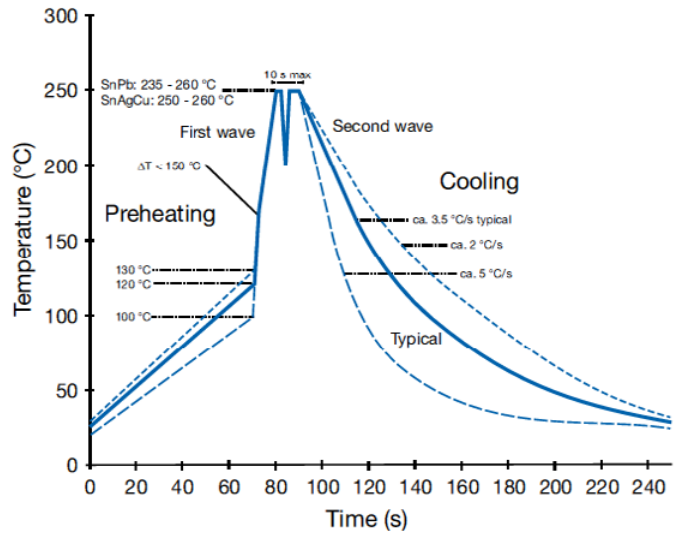

**Table 1 – Ratings & Part Number Reference**

Lead Spacing	Capacitance Value (µF)	B (mm)	H (mm)	L (mm)	VDC	VAC	dV/dt (V/µsec)	F Article Code	Part Number
5.0	2.2	6.0	11.0	7.2	50	30	200	SBCC4220AA10M	RSBCC4220AA10M
5.0	0.10	2.5	6.5	7.2	63	40	250	SBDC3100AA00M	RSBDC3100AA00M
5.0	0.15	2.5	6.5	7.2	63	40	250	SBDC3150AA00M	RSBDC3150AA00M
5.0	0.22	2.5	6.5	7.2	63	40	250	SBDC3220AA10M	RSBDC3220AA10M
5.0	0.33	3.5	7.5	7.2	63	40	250	SBDC3330AA00M	RSBDC3330AA00M
5.0	0.47	3.5	7.5	7.2	63	40	250	SBDC3470AA10M	RSBDC3470AA10M
5.0	0.68	4.5	9.5	7.2	63	40	250	SBDC3680AA10M	RSBDC3680AA10M
5.0	1.0	5.0	10.0	7.2	63	40	250	SBDC4100AA10M	RSBDC4100AA10M
5.0	1.5	6.0	11.0	7.2	63	40	250	SBDC4150AA10M	RSBDC4150AA10M
5.0	0.0047	2.5	6.5	7.2	100	63	300	SBEC1470AA00M	RSBEC1470AA00M
5.0	0.0068	2.5	6.5	7.2	100	63	300	SBEC1680AA00M	RSBEC1680AA00M
5.0	0.010	2.5	6.5	7.2	100	63	300	SBEC2100AA00M	RSBEC2100AA00M
5.0	0.015	2.5	6.5	7.2	100	63	300	SBEC2150AA00M	RSBEC2150AA00M
5.0	0.022	2.5	6.5	7.2	100	63	300	SBEC2220AA00M	RSBEC2220AA00M
5.0	0.033	2.5	6.5	7.2	100	63	300	SBEC2330AA00M	RSBEC2330AA00M
5.0	0.047	2.5	6.5	7.2	100	63	300	SBEC2470AA00M	RSBEC2470AA00M
5.0	0.068	2.5	6.5	7.2	100	63	300	SBEC2680AA10M	RSBEC2680AA10M
5.0	0.10	3.5	7.5	7.2	100	63	300	SBEC3100AA00M	RSBEC3100AA00M
5.0	0.15	4.5	9.5	7.2	100	63	300	SBEC3150AA00M	RSBEC3150AA00M
5.0	0.22	5.0	10.0	7.2	100	63	300	SBEC3220AA00M	RSBEC3220AA00M
5.0	0.33	6.0	11.0	7.2	100	63	300	SBEC3330AA00M	RSBEC3330AA00M
5.0	0.47	6.0	11.0	7.2	100	63	300	SBEC3470AA10M	RSBEC3470AA10M
5.0	0.001	2.5	6.5	7.2	250	160	400	SBIC1100AA00M	RSBIC1100AA00M
5.0	0.0015	2.5	6.5	7.2	250	160	400	SBIC1150AA00M	RSBIC1150AA00M
5.0	0.0022	2.5	6.5	7.2	250	160	400	SBIC1220AA00M	RSBIC1220AA00M
5.0	0.0033	2.5	6.5	7.2	250	160	400	SBIC1330AA00M	RSBIC1330AA00M
5.0	0.0047	2.5	6.5	7.2	250	160	400	SBIC1470AA00M	RSBIC1470AA00M
5.0	0.0068	2.5	6.5	7.2	250	160	400	SBIC1680AA00M	RSBIC1680AA00M
5.0	0.010	2.5	6.5	7.2	250	160	400	SBIC2100AA00M	RSBIC2100AA00M
5.0	0.015	2.5	6.5	7.2	250	160	400	SBIC2150AA00M	RSBIC2150AA00M
5.0	0.022	3.5	7.5	7.2	250	160	400	SBIC2220AA00M	RSBIC2220AA00M
5.0	0.033	3.5	7.5	7.2	250	160	400	SBIC2330AA00M	RSBIC2330AA00M
5.0	0.047	4.5	9.5	7.2	250	160	400	SBIC2470AA00M	RSBIC2470AA00M
5.0	0.068	4.5	9.5	7.2	250	160	400	SBIC2680AA00M	RSBIC2680AA00M
5.0	0.10	5.0	10.0	7.2	250	160	400	SBIC3100AA00M	RSBIC3100AA00M
5.0	0.15	6.0	11.0	7.2	250	160	400	SBIC3150AA00M	RSBIC3150AA00M
5.0	0.001	2.5	6.5	7.2	400	200	600	SBMC1100AA00M	RSBMC1100AA00M
5.0	0.0015	2.5	6.5	7.2	400	200	600	SBMC1150AA00M	RSBMC1150AA00M
5.0	0.0022	2.5	6.5	7.2	400	200	600	SBMC1220AA00M	RSBMC1220AA00M
5.0	0.0033	2.5	6.5	7.2	400	200	600	SBMC1330AA00M	RSBMC1330AA00M
5.0	0.0047	2.5	6.5	7.2	400	200	600	SBMC1470AA00M	RSBMC1470AA00M
5.0	0.0068	3.5	7.5	7.2	400	200	600	SBMC1680AA00M	RSBMC1680AA00M
5.0	0.010	3.5	7.5	7.2	400	200	600	SBMC2100AA00M	RSBMC2100AA00M
5.0	0.015	3.5	7.5	7.2	400	200	600	SBMC2150AA00M	RSBMC2150AA00M
5.0	0.022	4.5	9.5	7.2	400	200	600	SBMC2220AA00M	RSBMC2220AA00M
5.0	0.033	5.0	10.0	7.2	400	200	600	SBMC2330AA00M	RSBMC2330AA00M
5.0	0.047	6.0	11.0	7.2	400	200	600	SBMC2470AA00M	RSBMC2470AA00M
5.0	0.001	2.5	6.5	7.2	500	220	700	SBWC1100AA00M	RSBWC1100AA00M
5.0	0.0015	2.5	6.5	7.2	500	220	700	SBWC1150AA00M	RSBWC1150AA00M
5.0	0.0022	3.5	7.5	7.2	500	220	700	SBWC1220AA00M	RSBWC1220AA00M
5.0	0.0033	3.5	7.5	7.2	500	220	700	SBWC1330AA00M	RSBWC1330AA00M
5.0	0.0047	3.5	7.5	7.2	500	220	700	SBWC1470AA00M	RSBWC1470AA00M
5.0	0.0068	4.5	9.5	7.2	500	220	700	SBWC1680AA00M	RSBWC1680AA00M
5.0	0.010	5.0	10.0	7.2	500	220	700	SBWC2100AA00M	RSBWC2100AA00M
5.0	0.015	6.0	11.0	7.2	500	220	700	SBWC2150AA00M	RSBWC2150AA00M
5.0	0.001	2.5	6.5	7.2	630	220	800	SBPC1100AA00M	RSBPC1100AA00M
5.0	0.0015	3.5	7.5	7.2	630	220	800	SBPC1150AA00M	RSBPC1150AA00M
5.0	0.0022	3.5	7.5	7.2	630	220	800	SBPC1220AA00M	RSBPC1220AA00M
5.0	0.0033	4.5	9.5	7.2	630	220	800	SBPC1330AA00M	RSBPC1330AA00M
5.0	0.0047	4.5	9.5	7.2	630	220	800	SBPC1470AA00M	RSBPC1470AA00M
5.0	0.0068	5.0	10.0	7.2	630	220	800	SBPC1680AA00M	RSBPC1680AA00M
5.0	0.010	6.0	11.0	7.2	630	220	800	SBPC2100AA00M	RSBPC2100AA00M
Lead Spacing	Capacitance Value (µF)	B (mm)	H (mm)	L (mm)	VDC	VAC	dV/dt (V/µsec)	F Article Code	Part Number

## Soldering Process

The implementation of the RoHS Directive has required the selection SnAuCu (SAC) alloys or SnCu alloys as primary solder. This has increased the liquidus temperature from that of 183°C for SnPb eutectic alloy to 217°C – 221°C for the new alloys. As a result, the heat stress to components, even in wave soldering, has increased considerably due to higher pre-heat and wave temperatures. Wave soldering can be destructive especially for mechanically small polypropylene capacitors and great care must be taken during soldering. The solder profiles from KEMET are highly recommended. You may also refer to the wave soldering curve from IEC Publication 61760–1 Edition 2. Please consult KEMET with any questions.



## Marking

- Manufacturer's logo
- Article series
- Rated capacitance
- Capacitance tolerance
- Rated voltage
- Manufacturing date code
- IEC climatic category
- Passive flammability class
- Manufacturing date code

## Packaging Quantities

Lead Spacing	Thickness	Height	Length	Bulk Short Leads	Bulk Long Leads	Standard Reel 355 mm	Ammo
5	2.5	6.5	7.2	3000	4000	2500	3500
	3.5	7.5	7.2	2000	3000	1800	2500
	4.5	9.5	7.2	1500	2000	1400	1900
	5	10	7.2	1000	1500	1200	1700
	6	11	7.2	2000	1000	1000	1400
	7.2	13	7.2	1500	750	800	1150



## Lead Taping & Packaging (IEC 60286-2)

Figure 1 – Lead Space 5 & 7.5 mm

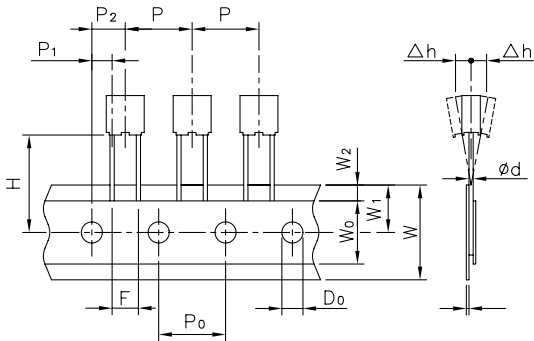
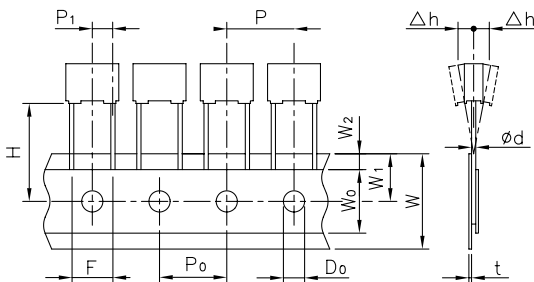
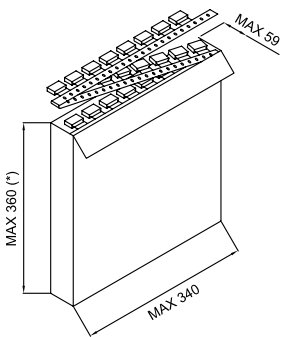

Figure 2 – Lead Space 7.5 mm



### Packaging Option 1 – Ammo Pack Lead Space 5 & 7.5 mm



\*Lower dimension available upon request (max. 295 mm).

### Packaging Option 2 – Reel $\varnothing$ 355 mm Lead Space 5 & 7.5 mm

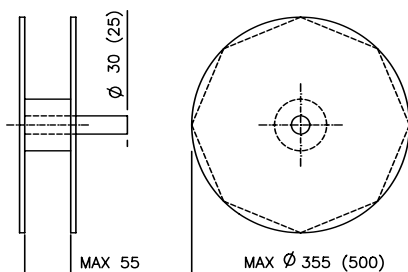

## Dimensions

Description	Symbol	Dimensions (mm)			
		Lead Space			Tol.
		5 Fig. 1	7.5 Fig. 1	7.5 Fig. 2	
Lead wire diameter	d	0.5–0.6	0.5–0.6	0.5–0.6	±0.05
Taping lead space	P	12.7	12.7	12.7	±1
Feed hole lead space	P <sub>0</sub>	12.7	12.7	12.7	±0.2*
Centering of the lead wire	P <sub>1</sub>	3.85	2.6	3.75	±0.7
Centering of the body	P <sub>2</sub>	6.35	6.35		±1.3
Lead spacing	F	5	7.5	7.5	+0.6 -0.1
Component alignment	$\Delta h$	0	0	0	±2
Height of component from tape center	H**	18.5	18.5	18.5	±0.5
Carrier tape width	W	18	18	18	+1 -0.5
Hold down tape width	W <sub>0</sub>	6	6	6	min.
Hole position	W <sub>1</sub>	9	9	9	±0.5
Hold down tape position	W <sub>2</sub>	3	3	3	max.
Feed hole diameter	D <sub>0</sub>	4	4	4	±0.2
Tape thickness	t	0.7	0.7	0.7	±0.2

\*Max 1 mm on 20 lead spaces.

\*\*H = 16.5 mm is available upon request.

For orders of capacitors with lead space = 7.5 mm, please specify the requested version (Figure 1 or Figure 2).

## Number of Pieces per Packing Unit

Dimensions (mm)			Lead Space (p)	Loose		Ammo (Pieces)	Reel $\varnothing$ 355 mm (Pieces)
B	H	L		*Short Leads (Pieces)	**Long Leads (Pieces)		
2.5	6.5	7.2	5.0	3000	4000	3500	2500
3.5	7.5	7.2	5.0	2000	3000	2500	1800
4.5	9.5	7.2	5.0	1500	2000	1900	1400
5.0	10.0	7.2	5.0	1000	1500	1700	1200
6.0	11.0	7.2	5.0	2000	1000	1400	1000
7.2	13.0	7.2	5.0	1500	750	1150	800
3.0	8.0	10.0	7.5	1500	1750	2800	2100
4.0	9.0	10.0	7.5	2000	1500	2100	1500
5.0	10.5	10.0	7.5	1500	1000	1600	1200
6.0	12.0	10.5	7.5	1000	800	1350	1000

\*Short leads, lead length = 04 + 1.5 mm (lead space = 5 mm); 4 + 2 mm (lead space = 7.5 mm).

\*\*Long leads, lead length = 17 + 1/2 mm.

## Lead Taping & Packaging (IEC 60286–2) cont'd

Figure 3 – Lead Space 10 mm

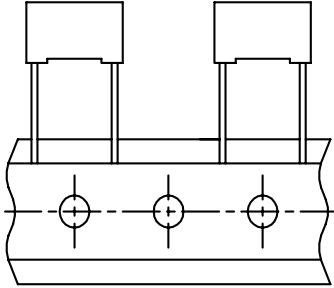

Figure 4 – Lead Space 15 mm

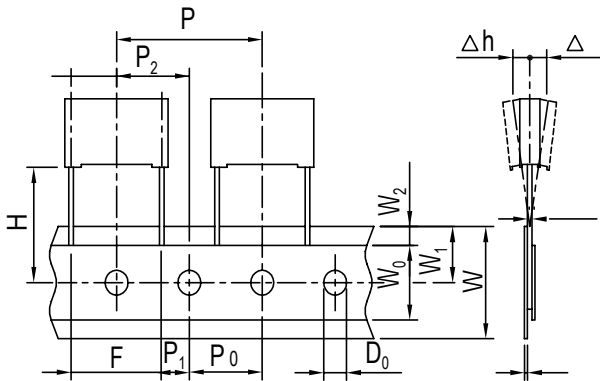
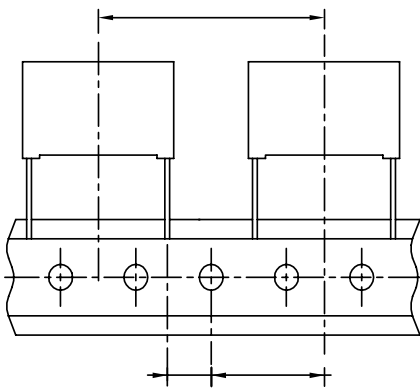

Figure 5 – Lead Space 22.5 & 27.5 mm



## Dimensions

Description	Symbol	Dimensions (mm)				
		Lead Space				Tol.
		10 Fig. 3	15 Fig. 4	22.5 Fig. 5	27.5 Fig. 5	
Lead wire diameter	d	0.6	0.6/0.8	0.8	0.8	±0.05
Taping lead space	P	25.4	25.4	38.1	38.1	±1
Feed hole lead space*	P <sub>0</sub>	12.7	12.7	12.7	12.7	±0.2**
Centering of the lead wire	P <sub>1</sub>	7.7	5.2	7.8	5.3	±0.7
Centering of the body	P <sub>2</sub>	12.7	12.7	19.05	19.05	±1.3
Lead spacing***	F	10	15	22.5	27.5	+ 0.6 - 0.1
Component alignment	Δh	0	0	0	0	±2
Height of component from tape center	H****	18.5	18.5	18.5	18.5	±0.5
Carrier tape width	W	18	18	18	18	+1 -0.5
Hold down tape width	W <sub>0</sub>	9	10	10	10	min.
Hole position	W <sub>1</sub>	9	9	9	9	±0.5
Hold down tape position	W <sub>2</sub>	3	3	3	3	max.
Feed hole diameter	D <sub>0</sub>	4	4	4	4	±0.2
Tape thickness	t	0.7	0.7	0.7	0.7	±0.2

\*Available also 15 mm.

\*\*Max 1 mm on 20 lead spaces.

\*\*\*Lead spaces 15 mm and 10 mm taped to 7.5 mm (crimped leads) available upon request.

\*\*\*\*H = 16.5 mm is available upon request.

# Not for new design. Please use new F622 Series

Film Through-Hole Capacitors

General Purpose Metallized Polyester Film Capacitors – RSB Series, 5 – 37.5 mm Lead Spacing, 50 – 630 VDC



## KEMET Corporation World Headquarters

2835 KEMET Way  
Simpsonville, SC 29681

Mailing Address:  
P.O. Box 5928  
Greenville, SC 29606

www.kemet.com  
Tel: 864-963-6300  
Fax: 864-963-6521

**Corporate Offices**  
Fort Lauderdale, FL  
Tel: 954-766-2800

## North America

**Southeast**  
Lake Mary, FL  
Tel: 407-855-8886

**Northeast**  
Wilmington, MA  
Tel: 978-658-1663

**Central**  
Novi, MI  
Tel: 248-994-1030

**West**  
Milpitas, CA  
Tel: 408-433-9950

**Mexico**  
Guadalajara, Jalisco  
Tel: 52-33-3123-2141

## Europe

**Southern Europe**  
Paris, France  
Tel: 33-1-4646-1006

**Sasso Marconi, Italy**  
Tel: 39-051-939111

**Central Europe**  
Landsberg, Germany  
Tel: 49-8191-3350800

**Kamen, Germany**  
Tel: 49-2307-438110

**Northern Europe**  
Bishop's Stortford, United Kingdom  
Tel: 44-1279-460122

**Espoo, Finland**  
Tel: 358-9-5406-5000

## Asia

**Northeast Asia**  
Hong Kong  
Tel: 852-2305-1168

**Shenzhen, China**  
Tel: 86-755-2518-1306

**Beijing, China**  
Tel: 86-10-5829-1711

**Shanghai, China**  
Tel: 86-21-6447-0707

**Taipei, Taiwan**  
Tel: 886-2-27528585

**Southeast Asia**  
Singapore  
Tel: 65-6586-1900

**Penang, Malaysia**  
Tel: 60-4-6430200

**Bangalore, India**  
Tel: 91-806-53-76817

*Note: KEMET reserves the right to modify minor details of internal and external construction at any time in the interest of product improvement. KEMET does not assume any responsibility for infringement that might result from the use of KEMET Capacitors in potential circuit designs. KEMET is a registered trademark of KEMET Electronics Corporation.*

# Not for new design. Please use new F622 Series

Film Through-Hole Capacitors

General Purpose Metallized Polyester Film Capacitors – RSB Series, 5 – 37.5 mm Lead Spacing, 50 – 630 VDC



## Other KEMET Resources

Tools	
Resource	Location
Configure A Part: CapEdge	<a href="http://capacitoredge.kemet.com">http://capacitoredge.kemet.com</a>
SPICE & FIT Software	<a href="http://www.kemet.com/spice">http://www.kemet.com/spice</a>
Search Our FAQs: KnowledgeEdge	<a href="http://www.kemet.com/keask">http://www.kemet.com/keask</a>
Electrolytic LifeCalculator	<a href="http://www.kemet.com:8080/elc">http://www.kemet.com:8080/elc</a>

Product Information	
Resource	Location
Products	<a href="http://www.kemet.com/products">http://www.kemet.com/products</a>
Technical Resources (Including Soldering Techniques)	<a href="http://www.kemet.com/technicalpapers">http://www.kemet.com/technicalpapers</a>
RoHS Statement	<a href="http://www.kemet.com/rohs">http://www.kemet.com/rohs</a>
Quality Documents	<a href="http://www.kemet.com/qualitydocuments">http://www.kemet.com/qualitydocuments</a>

Product Request	
Resource	Location
Sample Request	<a href="http://www.kemet.com/sample">http://www.kemet.com/sample</a>
Engineering Kit Request	<a href="http://www.kemet.com/kits">http://www.kemet.com/kits</a>

Contact	
Resource	Location
Website	<a href="http://www.kemet.com">www.kemet.com</a>
Contact Us	<a href="http://www.kemet.com/contact">http://www.kemet.com/contact</a>
Investor Relations	<a href="http://www.kemet.com/ir">http://www.kemet.com/ir</a>
Call Us	1-877-MyKEMET
Twitter	<a href="http://twitter.com/kemetcapacitors">http://twitter.com/kemetcapacitors</a>

## Disclaimer

All product specifications, statements, information and data (collectively, the "Information") in this datasheet are subject to change. The customer is responsible for checking and verifying the extent to which the Information contained in this publication is applicable to an order at the time the order is placed.

All Information given herein is believed to be accurate and reliable, but it is presented without guarantee, warranty, or responsibility of any kind, expressed or implied.

Statements of suitability for certain applications are based on KEMET Electronics Corporation's ("KEMET") knowledge of typical operating conditions for such applications, but are not intended to constitute – and KEMET specifically disclaims – any warranty concerning suitability for a specific customer application or use. The Information is intended for use only by customers who have the requisite experience and capability to determine the correct products for their application. Any technical advice inferred from this Information or otherwise provided by KEMET with reference to the use of KEMET's products is given gratis, and KEMET assumes no obligation or liability for the advice given or results obtained.

Although KEMET designs and manufactures its products to the most stringent quality and safety standards, given the current state of the art, isolated component failures may still occur. Accordingly, customer applications which require a high degree of reliability or safety should employ suitable designs or other safeguards (such as installation of protective circuitry or redundancies) in order to ensure that the failure of an electrical component does not result in a risk of personal injury or property damage.

Although all product-related warnings, cautions and notes must be observed, the customer should not assume that all safety measures are indicated or that other measures may not be required.

# Not for new design. Please use new F622 Series

Film Through-Hole Capacitors

General Purpose Metallized Polyester Film Capacitors – RSB Series, 5 – 37.5 mm Lead Spacing, 50 – 630 VDC

---

